

# SIGNATURE SERIES

## Comparators

LM393xxx LM2903xx LM339xx LM2901xx

### General Description

LM393xxx, LM2903xx, LM339xx, and LM2901xx monolithic ICs integrate two or four independent comparator circuits on a single chip and feature high gain, low power consumption, and an operating voltage range from 2V to 36V (single power supply).

### Features

- Operable with a Single Power Supply
- Wide Operating Supply Voltage Range
- Input / Output Ground Sense
- Low Supply Current
- Open Collector
- Wide Temperature Range

### Application

- Consumer Electronics
- Current Sense Application
- Battery Monitor
- Multivibrator

### Key Specifications

- Operating Supply Voltage:
  - Single Supply +2V to +36V
  - Dual Supply ±1V to ±18V
- Supply Current:
  - LM393xxx/LM2903xx 0.4mA (Typ)
  - LM339xx/LM2901xx 1.1mA (Typ)
- Input Bias Current: 25nA (Typ)
- Input Offset Current: 5nA (Typ)
- Temperature Range:
  - LM393xx/LM339xxx -40°C to +85°C
  - LM2903xx/LM2901xx -40°C to +125°C

### Packages

|              | W(Typ) x D(Typ) x H(Max) |
|--------------|--------------------------|
| SO Package8  | 4.90mm x 6.0mm x 1.55mm  |
| TSSOP8       | 3.00mm x 6.4mm x 1.10mm  |
| Mini SO8     | 3.00mm x 4.9mm x 0.95mm  |
| SO Package14 | 8.65mm x 6.0mm x 1.55mm  |
| TSSOP14      | 5.00mm x 6.4mm x 1.10mm  |

### Pin Configuration

|                          |                                 |
|--------------------------|---------------------------------|
| SO Package8:<br>(SOP-J8) | LM393DT<br>LM393WDT<br>LM2903DT |
| TSSOP8:<br>(TSSOP-B8)    | LM393PT<br>LM393WPT<br>LM2903PT |
| Mini SO8:<br>(TSSOP-B8J) | LM393ST                         |

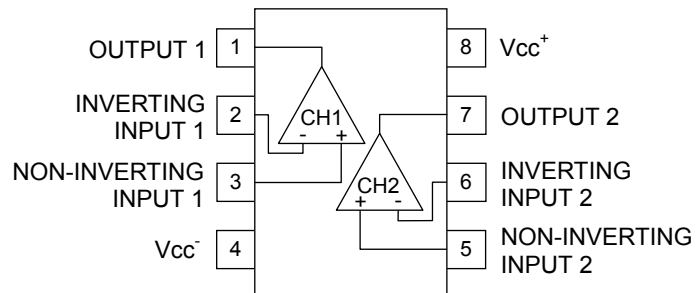

### Pin Description

LM393xxx/LM2903xx

| Pin No. | Pin Name              | Function                |
|---------|-----------------------|-------------------------|
| 1       | OUTPUT 1              | CH1 Output              |
| 2       | INVERTING INPUT 1     | CH1 Inverting Input     |
| 3       | NON-INVERTING INPUT 1 | CH1 Non-inverting Input |
| 4       | Vcc <sup>-</sup>      | Negative power supply   |
| 5       | NON-INVERTING INPUT 2 | CH2 Non-inverting Input |
| 6       | INVERTING INPUT 2     | CH2 Inverting Input     |
| 7       | OUTPUT 2              | CH2 Output              |
| 8       | Vcc <sup>+</sup>      | Positive power supply   |

**Pin Configuration**

SO Package14: LM339DT  
(SOP-J14) LM2901DT

TSSOP14: LM339PT  
(TSSOP-B14J) LM2901PT

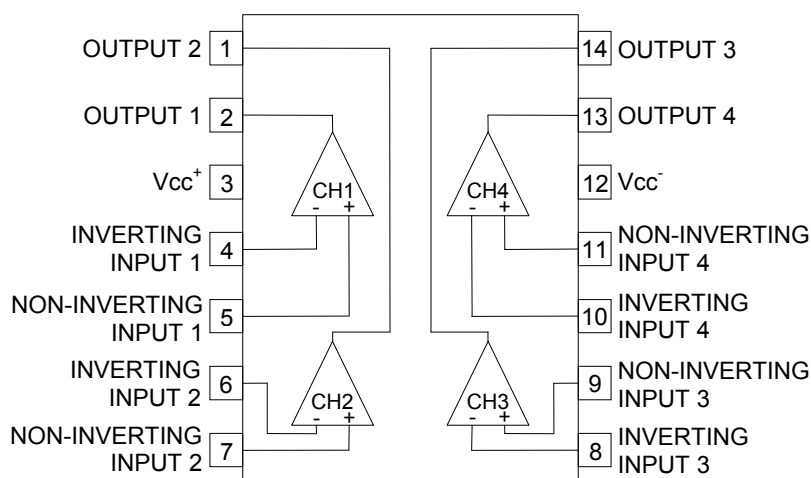

**Pin Description**

LM339xx/LM2901xx

| Pin No. | Pin Name              | Function                |
|---------|-----------------------|-------------------------|
| 1       | OUTPUT 2              | CH2 Output              |
| 2       | OUTPUT 1              | CH1 Output              |
| 3       | Vcc <sup>+</sup>      | Positive power supply   |
| 4       | INVERTING INPUT 1     | CH1 Inverting Input     |
| 5       | NON-INVERTING INPUT 1 | CH1 Non-inverting Input |
| 6       | INVERTING INPUT 2     | CH2 Inverting Input     |
| 7       | NON-INVERTING INPUT 2 | CH2 Non-inverting Input |
| 8       | INVERTING INPUT 3     | CH3 Inverting Input     |
| 9       | NON-INVERTING INPUT 3 | CH3 Non-inverting Input |
| 10      | INVERTING INPUT 4     | CH4 Inverting Input     |
| 11      | NON-INVERTING INPUT 4 | CH4 Non-inverting Input |
| 12      | Vcc <sup>-</sup>      | Negative power supply   |
| 13      | OUTPUT 4              | CH4 Output              |
| 14      | OUTPUT 3              | CH3 Output              |

Circuit Diagram

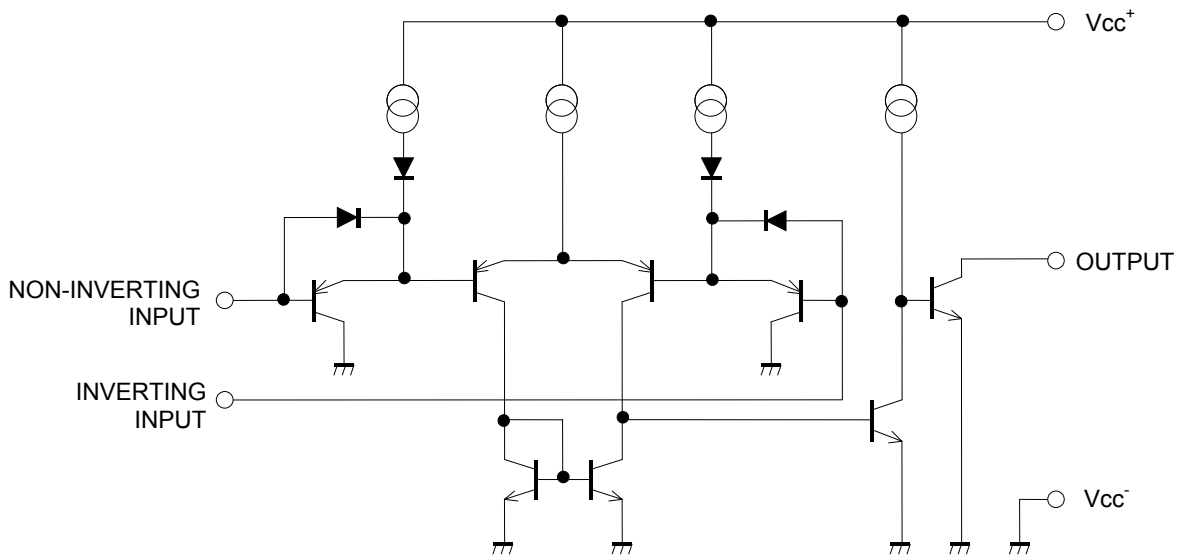

Figure 1. Circuit Diagram (each channel)

Absolute Maximum Ratings (T<sub>A</sub>=25°C)

| Parameter                                      | Symbol                             | Ratings   |                            |                            |                            | Unit                       |   |
|--|------------------------------------|---|----------------------------|----------------------------|----------------------------|----------------------------|---|
|  |                                    | LM393xxx  | LM339xx                    | LM2903xx                   | LM2901xx                   |                            |   |
| Supply Voltage                                 | V <sub>CC+</sub> -V <sub>CC-</sub> | +36   |                            |                            |                            | V                          |   |
| Power Dissipation                              | P <sub>D</sub>                     | SO Package8                                       | 0.67 <sup>(Note 1,6)</sup> | -                          | 0.67 <sup>(Note 1,6)</sup> | -                          | W |
|  |                                    | TSSOP8  | 0.62 <sup>(Note 2,6)</sup> | -                          | 0.62 <sup>(Note 2,6)</sup> | -                          |   |
|  |                                    | Mini SO8  | 0.58 <sup>(Note 3,6)</sup> | -                          | -                          | -                          |   |
|  |                                    | SO Package14                                      | -                          | 1.02 <sup>(Note 4,6)</sup> | -                          | 1.02 <sup>(Note 4,6)</sup> |   |
|  |                                    | TSSOP14   | -                          | 0.84 <sup>(Note 5,6)</sup> | -                          | 0.84 <sup>(Note 5,6)</sup> |   |
| Differential Input Voltage <sup>(Note 7)</sup> | V <sub>ID</sub>                    | +36   |                            |                            |                            | V                          |   |
| Input Common-mode Voltage Range                | V <sub>ICM</sub>                   | (V <sub>CC-</sub> -0.3) to (V <sub>CC+</sub> +36) |                            |                            |                            | V                          |   |
| Input Current <sup>(Note 8)</sup>              | I <sub>I</sub>                     | -10   |                            |                            |                            | mA                         |   |
| Operating Supply Voltage                       | V <sub>opr</sub>                   | +2.0 to +36.0<br>(±1.0 to ±18.0)                  |                            |                            |                            | V                          |   |
| Operating Temperature Range                    | T <sub>opr</sub>                   | -40 to +85  |                            | -40 to +125                |                            | °C                         |   |
| Storage Temperature Range                      | T <sub>stg</sub>                   | -55 to +150                                       |                            |                            |                            | °C                         |   |
| Maximum Junction Temperature                   | T <sub>jmax</sub>                  | +150  |                            |                            |                            | °C                         |   |

Note: Absolute maximum rating item indicates the condition which must not be exceeded. Application of voltage in excess of absolute maximum rating or use out of absolute maximum rated temperature environment may cause deterioration of characteristics.

(Note 1) To use at temperature above T<sub>A</sub>=25°C reduce 5.4mW.

(Note 2) To use at temperature above T<sub>A</sub>=25°C reduce 5.0mW.

(Note 3) To use at temperature above T<sub>A</sub>=25°C reduce 4.7mW.

(Note 4) To use at temperature above T<sub>A</sub>=25°C reduce 8.2mW.

(Note 5) To use at temperature above T<sub>A</sub>=25°C reduce 6.8mW.

(Note 6) Mounted on a FR4 glass epoxy PCB 70mm×70mm×1.6mm(Copper foil area less than 3%).

(Note 7) The voltage difference between inverting input and non-inverting input is the differential input voltage. The input terminal voltage is set to more than V<sub>CC-</sub>.

(Note 8) An excessive input current will flow when input voltages of less than V<sub>CC-</sub>-0.6V are applied. The input current can be set to less than the rated current by adding a limiting resistor.

**Caution:** Operating the IC over the absolute maximum ratings may damage the IC. The damage can either be a short circuit between pins or an open circuit between pins and the internal circuitry. Therefore, it is important to consider circuit protection measures, such as adding a fuse, in case the IC is operated over the absolute maximum ratings.

## Electric Characteristics

OLM393xxx(Unless otherwise specified  $V_{CC}^+=+5V$ ,  $V_{CC}^-=0V$ ,  $T_A=25^\circ C$ )

| Parameter   | Symbol     | Temperature Range | Limit |     |                | Unit    | Conditions   |
|---|------------|-------------------|-------|-----|----------------|---------|--|
|   |            |                   | Min   | Typ | Max            |         |  |
| Input Offset Voltage (Note 9,10)                                  | $V_{IO}$   | 25°C              | -     | 1   | 7              | mV      | $V_{CC}^+=5V$ to 30V, $V_O=1.4V$<br>$V_{ICM}=0$ to 1.5V                |
|   |            | Full range        | -     | -   | 9              |         |  |
| Input Offset Current (Note 9,10)                                  | $I_{IO}$   | 25°C              | -     | 5   | 50             | nA      | $V_O=1.4V$   |
|   |            | Full range        | -     | -   | 150            |         |  |
| Input Bias Current (Note 9,10)                                    | $I_{IB}$   | 25°C              | -     | 25  | 250            | nA      | $V_O=1.4V$   |
|   |            | Full range        | -     | -   | 400            |         |  |
| Large Signal Voltage Gain   | $A_V$      | 25°C              | 25    | 200 | -              | V/mV    | $V_{CC}^+=15V$<br>$V_O=1.4V$ to 11.4V, $R_L=15k\Omega$                 |
| Supply Current (Note 10)<br>(All Comparators)                     | $I_{CC}$   | 25°C              | -     | 0.4 | 1              | mA      | $V_{CC}^+=5V$ , No Load  |
|   |            | Full range        | -     | 1   | 2.5            |         | $V_{CC}^+=30V$ , No Load   |
| Input Common-mode Voltage Range (Note 10)                         | $V_{ICM}$  | 25°C              | 0     | -   | $V_{CC}^+-1.5$ | V       | -  |
|   |            | Full range        | 0     | -   | $V_{CC}^+-2.0$ |         |  |
| Output Saturation Voltage (Note 10)<br>(Low Level Output Voltage) | $V_{OL}$   | 25°C              | -     | 250 | 400            | mV      | $V_{ID}=-1V$ , $I_{SINK}=4mA$  |
|   |            | Full range        | -     | -   | 700            |         |  |
| Output Leakage Current (Note 10)<br>(High Level Output Current)   | $I_{LEAK}$ | 25°C              | -     | 0.1 | -              | nA      | $V_{CC}^+=30V$ , $V_{ID}=1V$<br>$V_O=30V$                              |
|   |            | Full range        | -     | -   | 1              |         |  |
| Output Sink Current (Note 10,11)                                  | $I_{SINK}$ | Full range        | 6     | 16  | -              | mA      | $V_{ID}=-1V$ , $V_O=1.5V$  |
| Small Signal Response Time  | $t_{RE}$   | 25°C              | -     | 1.3 | -              | $\mu s$ | $R_L=5.1k\Omega$ , $V_{RL}=5V$<br>$V_{IN}=100mVp-p$ ,<br>Overdrive=5mV |
| Large Signal Response Time  | $t_{REL}$  | 25°C              | -     | 300 | -              | ns      | $R_L=5.1k\Omega$ , $V_{RL}=5V$<br>$V_{IN}=TTL$ input, $V_{REF}=1.4V$   |

(Note 9) Absolute value

(Note 10) Full range:  $T_A=-40^\circ C$  to  $+85^\circ C$ 

(Note 11) Consider the power dissipation of the IC under high temperature environment when selecting the output current value.

There may be a case where the output current value is reduced due to the rise in IC temperature caused by the heat generated inside the IC.

## Electric Characteristics - continued

OLM339xx (Unless otherwise specified  $V_{CC}^+=+5V$ ,  $V_{CC}^-=0V$ ,  $T_A=25^\circ C$ )

| Parameter   | Symbol     | Temperature Range | Limit |     |                | Unit    | Conditions   |
|---|------------|-------------------|-------|-----|----------------|---------|--|
|   |            |                   | Min   | Typ | Max            |         |  |
| Input Offset Voltage (Note 12,13)                                 | $V_{IO}$   | 25°C              | -     | 1   | 7              | mV      | $V_{CC}^+=5V$ to 30V, $V_O=1.4V$<br>$V_{ICM}=0$ to 1.5V                |
|   |            | Full range        | -     | -   | 9              |         |  |
| Input Offset Current (Note 12,13)                                 | $I_{IO}$   | 25°C              | -     | 5   | 50             | nA      | $V_O=1.4V$   |
|   |            | Full range        | -     | -   | 150            |         |  |
| Input Bias Current (Note 12,13)                                   | $I_{IB}$   | 25°C              | -     | 25  | 250            | nA      | $V_O=1.4V$   |
|   |            | Full range        | -     | -   | 400            |         |  |
| Large Signal Voltage Gain   | $A_V$      | 25°C              | 25    | 200 | -              | V/mV    | $V_{CC}^+=15V$<br>$V_O=1.4V$ to 11.4V, $R_L=15k\Omega$                 |
| Supply Current (Note 13)<br>(All Comparators)                     | $I_{CC}$   | 25°C              | -     | 1.1 | 2              | mA      | $V_{CC}^+=5V$ , No Load  |
|   |            | Full range        | -     | 1.3 | 2.5            |         | $V_{CC}^+=30V$ , No Load   |
| Input Common-mode Voltage Range (Note 13)                         | $V_{ICM}$  | 25°C              | 0     | -   | $V_{CC}^+-1.5$ | V       | -  |
|   |            | Full range        | 0     | -   | $V_{CC}^+-2.0$ |         |  |
| Output Saturation Voltage (Note 13)<br>(Low Level Output Voltage) | $V_{OL}$   | 25°C              | -     | 250 | 400            | mV      | $V_{ID}=-1V$ , $I_{SINK}=4mA$  |
|   |            | Full range        | -     | -   | 700            |         |  |
| Output Leakage Current (Note 13)<br>(High Level Output Current)   | $I_{LEAK}$ | 25°C              | -     | 0.1 | -              | nA      | $V_{CC}^+=30V$ , $V_{ID}=1V$<br>$V_O=30V$                              |
|   |            | Full range        | -     | -   | 1              | $\mu A$ |  |
| Output Sink Current (Note 13,14)                                  | $I_{SINK}$ | Full range        | 6     | 16  | -              | mA      | $V_{ID}=-1V$ , $V_O=1.5V$  |
| Small Signal Response Time  | $t_{RE}$   | 25°C              | -     | 1.3 | -              | $\mu s$ | $R_L=5.1k\Omega$ , $V_{RL}=5V$<br>$V_{IN}=100mVp-p$ ,<br>Overdrive=5mV |
| Large Signal Response Time  | $t_{REL}$  | 25°C              | -     | 300 | -              | ns      | $R_L=5.1k\Omega$ , $V_{RL}=5V$<br>$V_{IN}=TTL$ input, $V_{REF}=1.4V$   |

(Note 12) Absolute value

(Note 13) Full range:  $T_A=-40^\circ C$  to  $+85^\circ C$ 

(Note 14) Consider the power dissipation of the IC under high temperature environment when selecting the output current value.

There may be a case where the output current value is reduced due to the rise in IC temperature caused by the heat generated inside the IC.

## Electric Characteristics - continued

OLM2903xx(Unless otherwise specified  $V_{CC}^+=+5V$ ,  $V_{CC}^-=0V$ ,  $T_A=25^\circ C$ )

| Parameter   | Symbol     | Temperature Range | Limit |     |                | Unit    | Conditions   |
|---|------------|-------------------|-------|-----|----------------|---------|--|
|   |            |                   | Min   | Typ | Max            |         |  |
| Input Offset Voltage (Note 15,16)                                 | $V_{IO}$   | 25°C              | -     | 2   | 7              | mV      | $V_{CC}^+=5V$ to 30V, $V_O=1.4V$<br>$V_{ICM}=0$ to 1.5V                              |
|   |            | Full range        | -     | -   | 15             |         |  |
| Input Offset Current (Note 15,16)                                 | $I_{IO}$   | 25°C              | -     | 5   | 50             | nA      | $V_O=1.4V$   |
|   |            | Full range        | -     | -   | 150            |         |  |
| Input Bias Current (Note 15,16)                                   | $I_{IB}$   | 25°C              | -     | 25  | 250            | nA      | $V_O=1.4V$   |
|   |            | Full range        | -     | -   | 400            |         |  |
| Large Signal Voltage Gain   | $A_V$      | 25°C              | 25    | 200 | -              | V/mV    | $V_{CC}^+=15V$<br>$V_O=1.4V$ to 11.4V, $R_L=15k\Omega$                               |
| Supply Current (Note 16)<br>(All Comparators)                     | $I_{CC}$   | 25°C              | -     | 0.4 | 1              | mA      | $V_{CC}^+=5V$ , No Load  |
|   |            | Full range        | -     | 1   | 2.5            |         | $V_{CC}^+=30V$ , No Load   |
| Input Common-mode Voltage Range (Note 16)                         | $V_{ICM}$  | 25°C              | 0     | -   | $V_{CC}^+-1.5$ | V       | -  |
|   |            | Full range        | 0     | -   | $V_{CC}^+-2.0$ |         |  |
| Output Saturation Voltage (Note 16)<br>(Low Level Output Voltage) | $V_{OL}$   | 25°C              | -     | 250 | 400            | mV      | $V_{ID}=-1V$ , $I_{SINK}=4mA$  |
|   |            | Full range        | -     | -   | 700            |         |  |
| Output Leakage Current (Note 16)<br>(High Level Output Current)   | $I_{LEAK}$ | 25°C              | -     | 0.1 | -              | nA      | $V_{CC}^+=30V$ , $V_{ID}=1V$<br>$V_O=30V$  |
|   |            | Full range        | -     | -   | 1              | $\mu A$ |  |
| Output Sink Current (Note 16,17)                                  | $I_{SINK}$ | Full range        | 6     | 16  | -              | mA      | $V_{ID}=-1V$ , $V_O=1.5V$  |
| Small Signal Response Time  | $t_{RE}$   | 25°C              | -     | 1.3 | -              | $\mu s$ | $R_L=5.1k\Omega$ , $V_{RL}=5V$<br>$V_{IN}=100mVp-p$ ,<br>Overdrive=5mV               |
| Large Signal Response Time  | $t_{REL}$  | 25°C              | -     | -   | 1.0            | $\mu s$ | $R_L=5.1k\Omega$ , $V_{RL}=5V$<br>$V_{IN}=TTL$ input, $V_{REF}=1.4V$<br>$V_O$ at 95% |

(Note 15) Absolute value

(Note 16) Full range:  $T_A=-40^\circ C$  to  $+125^\circ C$ 

(Note 17) Consider the power dissipation of the IC under high temperature environment when selecting the output current value.

There may be a case where the output current value is reduced due to the rise in IC temperature caused by the heat generated inside the IC.

## Electric Characteristics - continued

OLM2901xx (Unless otherwise specified  $V_{CC}^+=+5V$ ,  $V_{CC}^-=0V$ ,  $T_A=25^\circ C$ )

| Parameter   | Symbol     | Temperature Range | Limit |     |                | Unit    | Conditions   |
|---|------------|-------------------|-------|-----|----------------|---------|--|
|   |            |                   | Min   | Typ | Max            |         |  |
| Input Offset Voltage (Note 15,16)                                 | $V_{IO}$   | 25°C              | -     | 1   | 7              | mV      | $V_{CC}^+=5V$ to 30V, $V_O=1.4V$<br>$V_{ICM}=0$ to 1.5V                              |
|   |            | Full range        | -     | -   | 15             |         |  |
| Input Offset Current (Note 15,16)                                 | $I_{IO}$   | 25°C              | -     | 5   | 50             | nA      | $V_O=1.4V$   |
|   |            | Full range        | -     | -   | 150            |         |  |
| Input Bias Current (Note 15,16)                                   | $I_{IB}$   | 25°C              | -     | 25  | 250            | nA      | $V_O=1.4V$   |
|   |            | Full range        | -     | -   | 400            |         |  |
| Large Signal Voltage Gain   | $A_V$      | 25°C              | 25    | 200 | -              | V/mV    | $V_{CC}^+=15V$<br>$V_O=1.4V$ to 11.4V, $R_L=15k\Omega$                               |
| Supply Current (Note 16)<br>(All Comparators)                     | $I_{CC}$   | 25°C              | -     | 1.1 | 2              | mA      | $V_{CC}^+=5V$ , No Load  |
|   |            | Full range        | -     | 1.3 | 2.5            |         | $V_{CC}^+=30V$ , No Load   |
| Input Common-mode Voltage Range (Note 16)                         | $V_{ICM}$  | 25°C              | 0     | -   | $V_{CC}^+-1.5$ | V       | -  |
|   |            | Full range        | 0     | -   | $V_{CC}^+-2.0$ |         |  |
| Output Saturation Voltage (Note 16)<br>(Low Level Output Voltage) | $V_{OL}$   | 25°C              | -     | 250 | 400            | mV      | $V_{ID}=-1V$ , $I_{SINK}=4mA$  |
|   |            | Full range        | -     | -   | 700            |         |  |
| Output Leakage Current (Note 16)<br>(High Level Output Current)   | $I_{LEAK}$ | 25°C              | -     | 0.1 | -              | nA      | $V_{CC}^+=30V$ , $V_{ID}=1V$<br>$V_O=30V$  |
|   |            | Full range        | -     | -   | 1              | $\mu A$ |  |
| Output Sink Current (Note 16,17)                                  | $I_{SINK}$ | Full range        | 6     | 16  | -              | mA      | $V_{ID}=-1V$ , $V_O=1.5V$  |
| Small Signal Response Time  | $t_{RE}$   | 25°C              | -     | 1.3 | -              | $\mu s$ | $R_L=5.1k\Omega$ , $V_{RL}=5V$<br>$V_{IN}=100mVp-p$ ,<br>Overdrive=5mV               |
| Large Signal Response Time  | $t_{REL}$  | 25°C              | -     | -   | 1.0            | $\mu s$ | $R_L=5.1k\Omega$ , $V_{RL}=5V$<br>$V_{IN}=TTL$ input, $V_{REF}=1.4V$<br>$V_O$ at 95% |

(Note 18) Absolute value

(Note 19) Full range:  $T_A=-40^\circ C$  to  $+125^\circ C$ 

(Note 20) Consider the power dissipation of the IC under high temperature environment when selecting the output current value.

There may be a case where the output current value is reduced due to the rise in IC temperature caused by the heat generated inside the IC.

## Description of Electrical Characteristics

Described below are descriptions of the relevant electrical terms used in this datasheet. Items and symbols used are also shown. Note that item name and symbol and their meaning may differ from those on another manufacturer's document or general document.

### 1. Absolute maximum ratings

Absolute maximum rating items indicate the condition which must not be exceeded. Application of voltage in excess of absolute maximum rating or use out of absolute maximum rated temperature environment may cause deterioration of characteristics.

- (1) Supply Voltage ( $V_{CC}^+ / V_{CC}^-$ )  
Indicates the maximum voltage that can be applied between the positive power supply pin and negative power supply pin without deterioration or destruction of characteristics of internal circuit.
- (2) Differential Input Voltage ( $V_{ID}$ )  
Indicates the maximum voltage that can be applied between non-inverting and inverting pins without damaging the IC.
- (3) Input Common-mode Voltage Range ( $V_{ICM}$ )  
Indicates the maximum voltage that can be applied to the non-inverting and inverting pins without deterioration or destruction of electrical characteristics. Input common-mode voltage range of the maximum ratings does not assure normal operation of IC. For normal operation, use the IC within the input common-mode voltage range characteristics.
- (4) Operating and storage temperature ranges ( $T_{opr}$ ,  $T_{stg}$ )  
The operating temperature range indicates the temperature range within which the IC can operate. The higher the ambient temperature, the lower the power consumption of the IC. The storage temperature range denotes the range of temperatures the IC can be stored under without causing excessive deterioration of the electrical characteristics.
- (5) Power dissipation ( $P_D$ )  
Indicates the power that can be consumed by the IC when mounted on a specific board at ambient temperature 25°C (normal temperature). As for package product,  $P_D$  is determined by the temperature that can be permitted by the IC in the package (maximum junction temperature) and the thermal resistance of the package.

### 2. Electrical characteristics

- (1) Input Offset Voltage ( $V_{IO}$ )  
Indicates the voltage difference between non-inverting pin and inverting pins. It can be translated into the input voltage difference required for setting the output voltage at 0 V.
- (2) Input Offset Current ( $I_{IO}$ )  
Indicates the difference of input bias current between the non-inverting and inverting pins.
- (3) Input Bias Current ( $I_B$ )  
Indicates the current that flows into or out of the input pin. It is defined by the average of input bias currents at the non-inverting and inverting pins.
- (4) Large Signal Voltage Gain ( $A_V$ )  
Indicates the amplifying rate (gain) of output voltage against the voltage difference between non-inverting pin and inverting pin. It is normally the amplifying rate (gain) with reference to DC voltage.  
 $A_V = (\text{Output Voltage}) / (\text{Differential Input Voltage})$
- (5) Supply Current ( $I_{CC}$ )  
Indicates the current that flows within the IC under specified no-load conditions.
- (6) Input Common-mode Voltage Range ( $V_{ICM}$ )  
Indicates the input voltage range where IC normally operates.
- (7) Output Saturation Voltage, Low Level Output Voltage ( $V_{OL}$ )  
Signifies the voltage range that can be output under specific output conditions.
- (8) Output Leakage Current, High Level Output Current ( $I_{LEAK}$ )  
Indicates the current that flows into the IC under specific input and output conditions.
- (9) Output Sink Current ( $I_{SINK}$ )  
Denotes the maximum current that can be output from the IC under specific output conditions.
- (10) Response Time ( $t_{RE}$ )  
Response time indicates the delay time between the input and output signal which is determined by the time difference from the fifty percent of input signal swing to the fifty percent of output signal swing.



Typical Performance Curves

OLM393xxx/LM2903xx

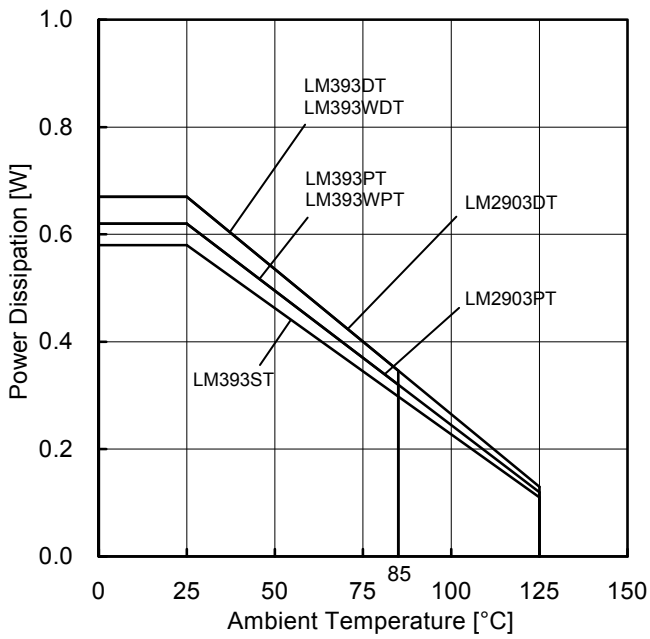

Figure 2. Power Dissipation vs Ambient Temperature (Derating Curve)

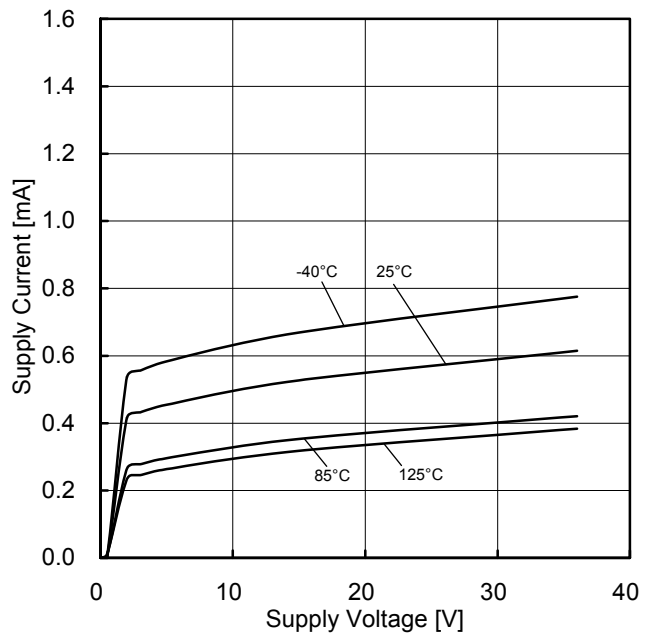

Figure 3. Supply Current vs Supply Voltage

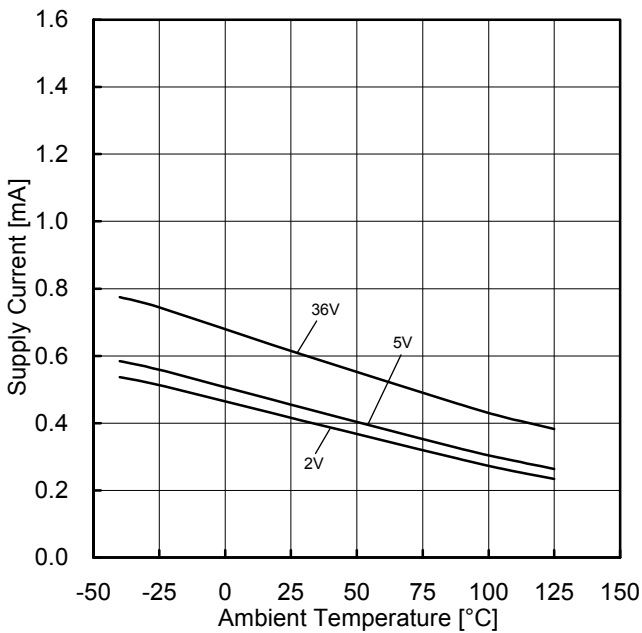

Figure 4. Supply Current vs Ambient Temperature

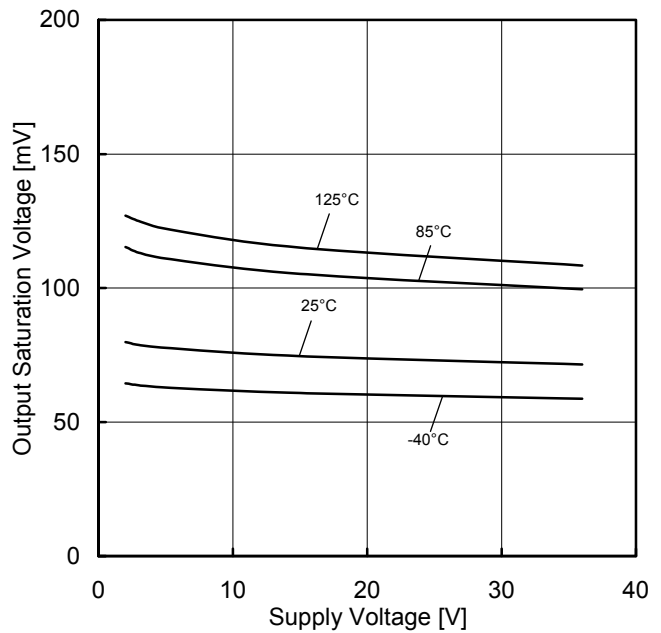

Figure 5. Output Saturation Voltage vs Supply Voltage ( $I_{SINK}=4mA$ )

(\*)The above characteristics are measurements of typical sample, they are not guaranteed.

LM393 : -40°C to +85°C LM2903 : -40°C to +125°C

Typical Performance Curves - continued

OLM393xxx/LM2903xx

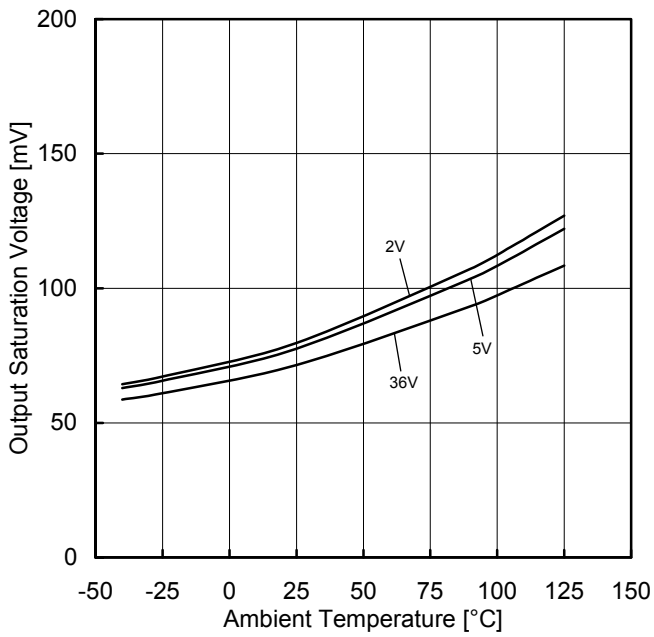

Figure 6. Output Saturation Voltage vs Ambient Temperature ( $I_{SINK}=4mA$ )

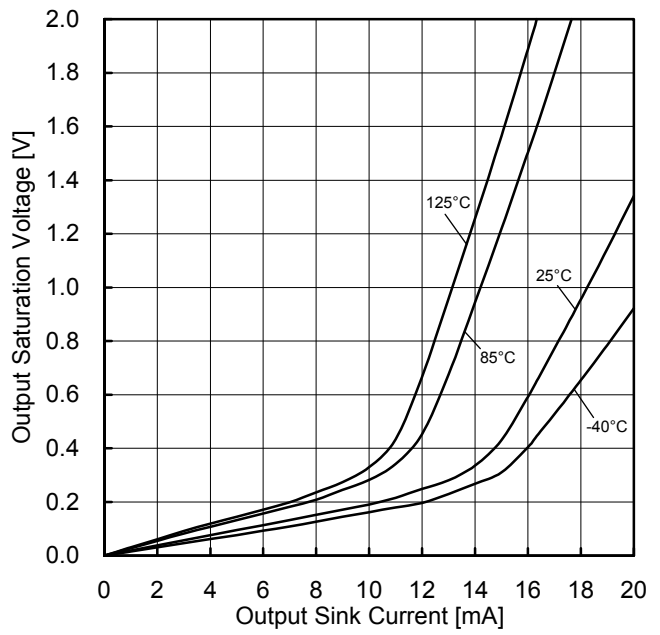

Figure 7. Output Saturation Voltage vs Output Sink Current ( $V_{CC+}=5V$ )

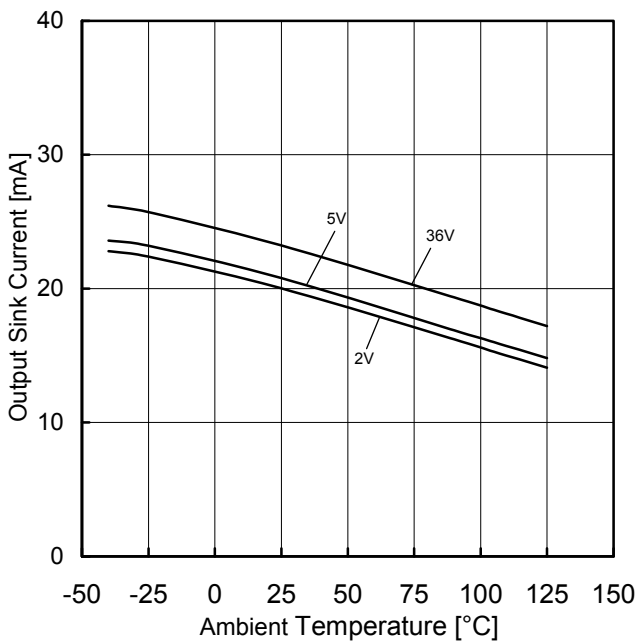

Figure 8. Output Sink Current vs Ambient Temperature ( $V_O=1.5V$ )

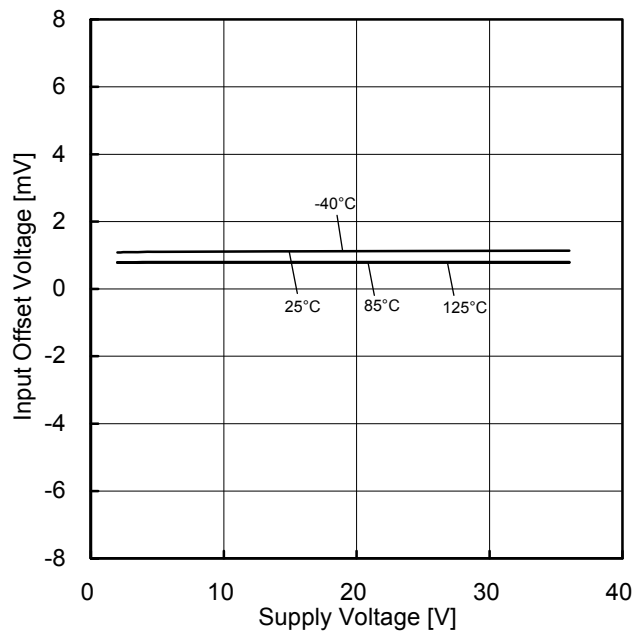

Figure 9. Input Offset Voltage vs Supply Voltage

(\*)The above characteristics are measurements of typical sample, they are not guaranteed.

LM393 : -40°C to +85°C LM2903 : -40°C to +125°C

Typical Performance Curves - continued

OLM393xxx/LM2903xx

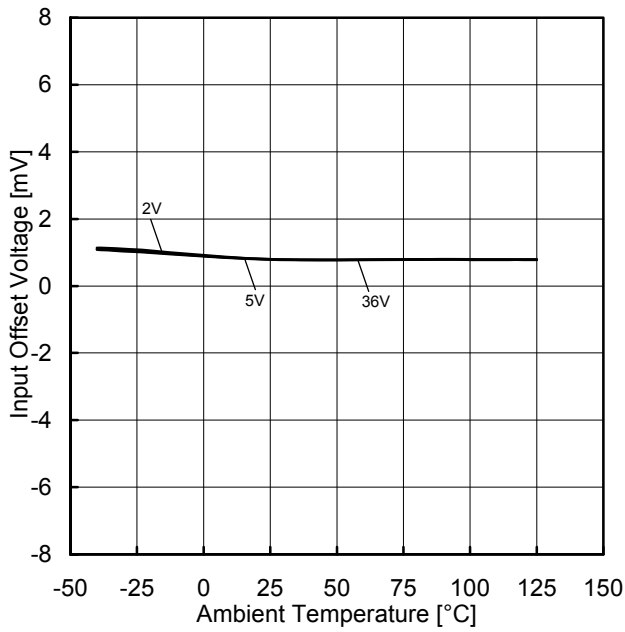

Figure 10. Input Offset Voltage vs Ambient Temperature

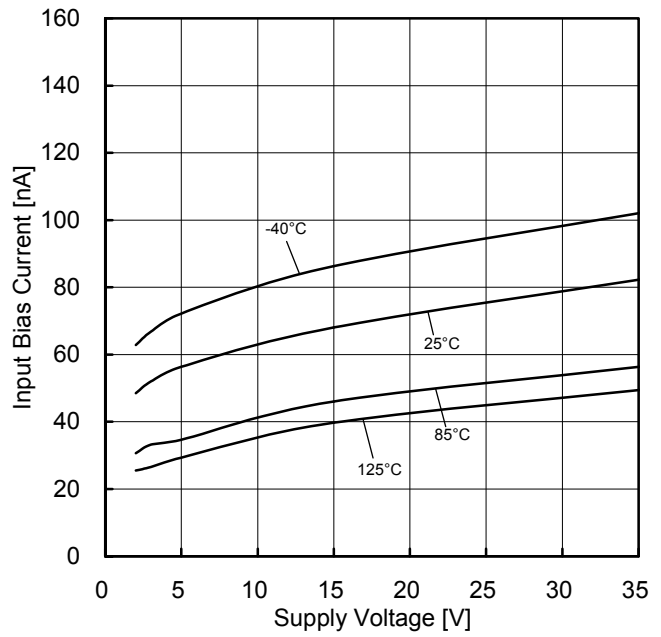

Figure 11. Input Bias Current vs Supply Voltage

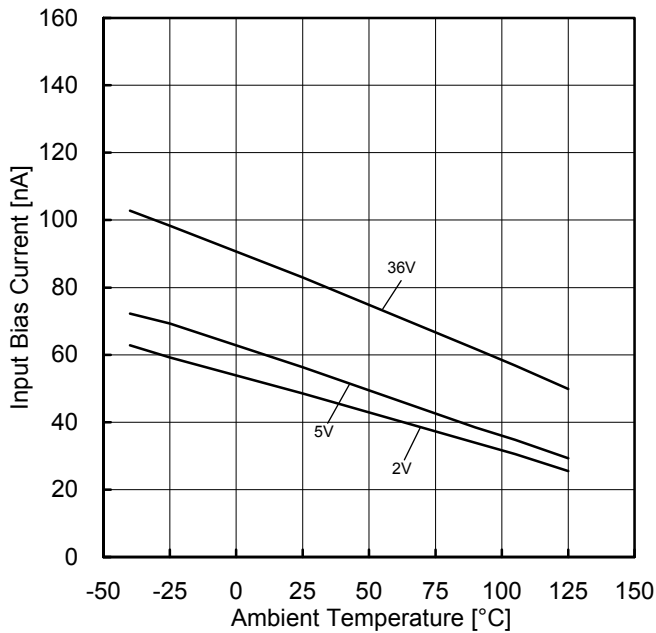

Figure 12. Input Bias Current vs Ambient Temperature

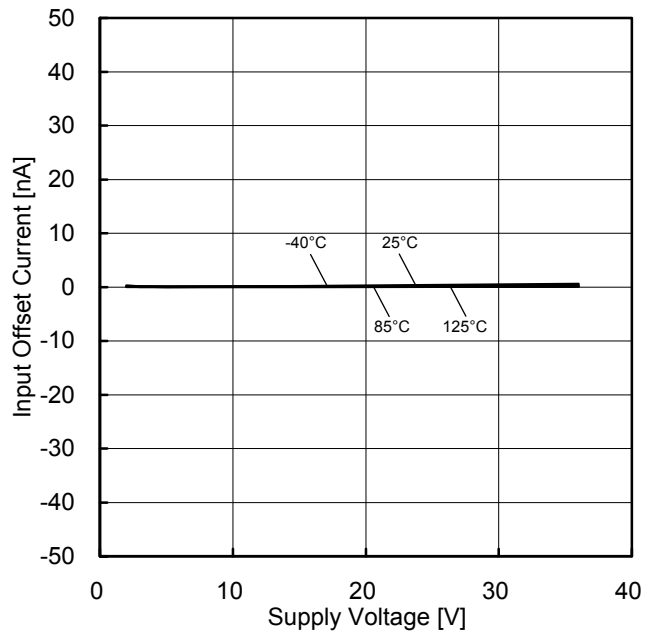

Figure 13. Input Offset Current vs Supply Voltage

(\*)The above characteristics are measurements of typical sample, they are not guaranteed.

LM393 : -40°C to +85°C LM2903 : -40°C to +125°C

Typical Performance Curves - continued

OLM393xxx/LM2903xx

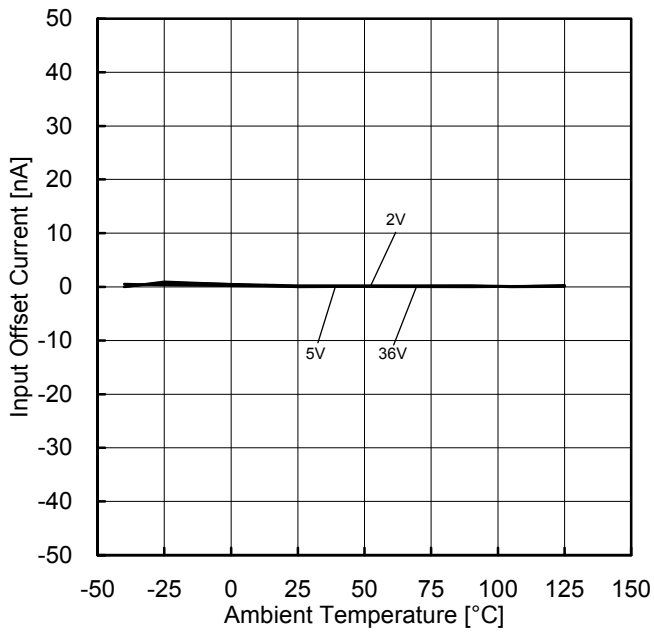

Figure 14. Input Offset Current vs Ambient Temperature

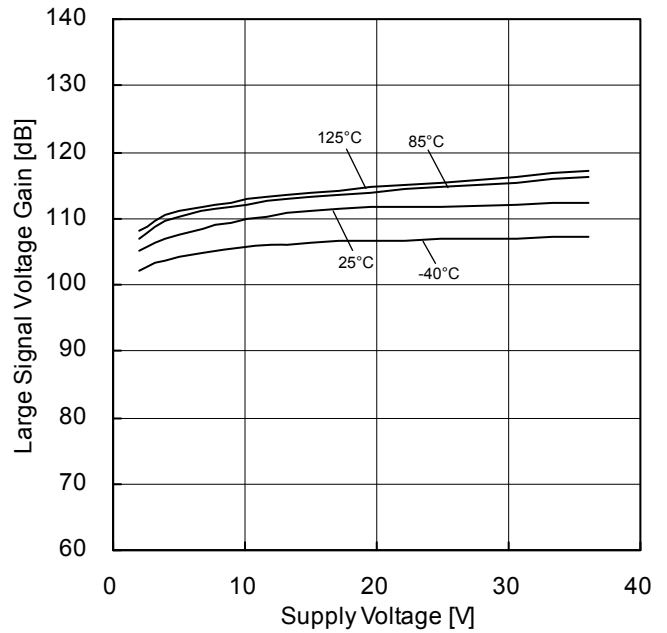

Figure 15. Large Signal Voltage Gain vs Supply Voltage

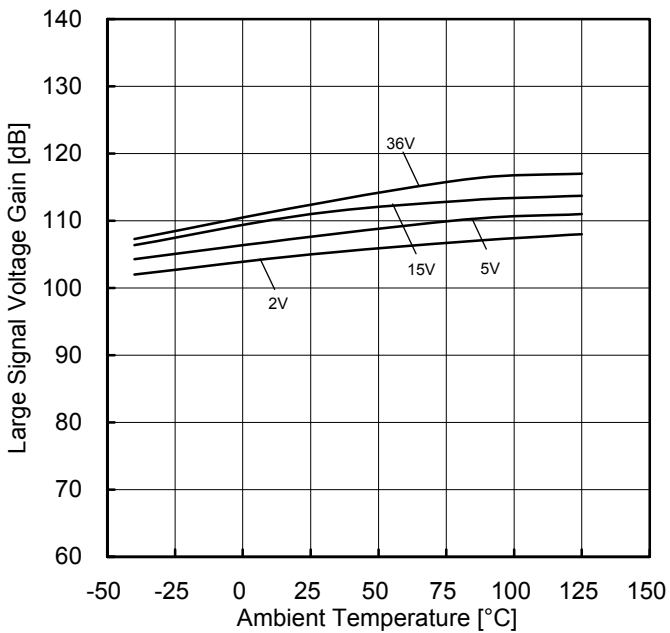

Figure 16. Large Signal Voltage Gain vs Ambient Temperature

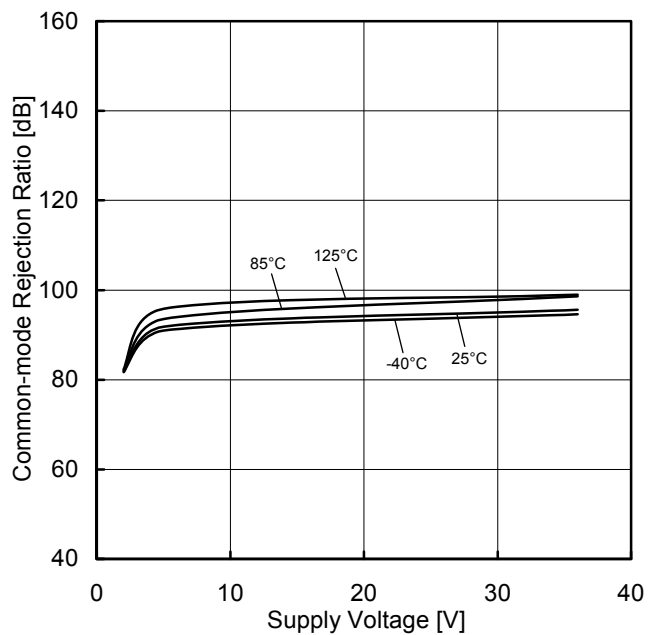

Figure 17. Common-mode Rejection Ratio vs Supply Voltage

(\*)The above characteristics are measurements of typical sample, they are not guaranteed.

LM393 : -40°C to +85°C LM2903 : -40°C to +125°C

Typical Performance Curves - continued

OLM393xxx/LM2903xx

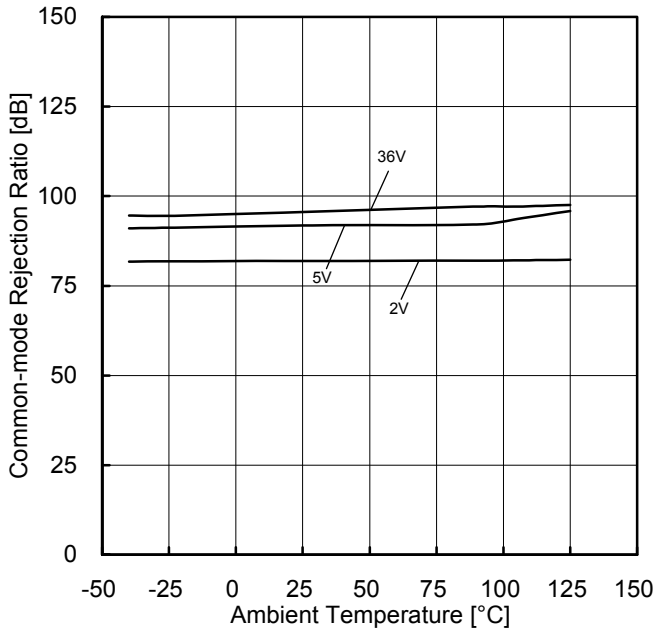

Figure 18. Common-mode Rejection Ratio vs Ambient Temperature

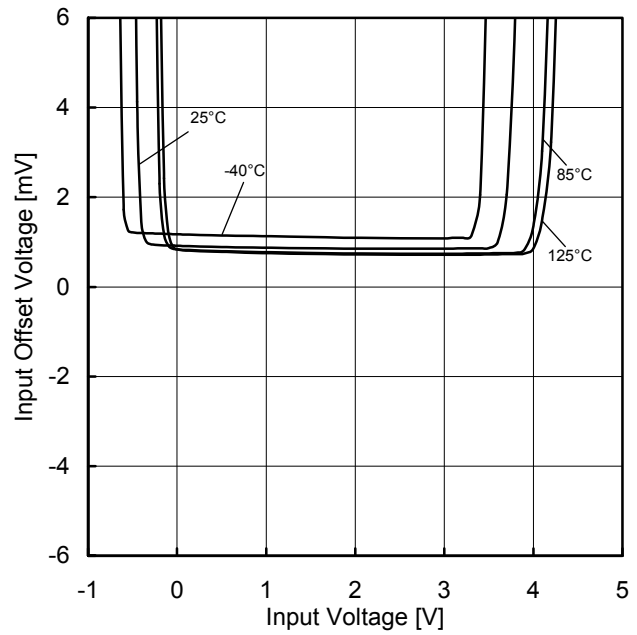

Figure 19. Input Offset Voltage vs Input Voltage ( $V_{CC^+}=5V$ )

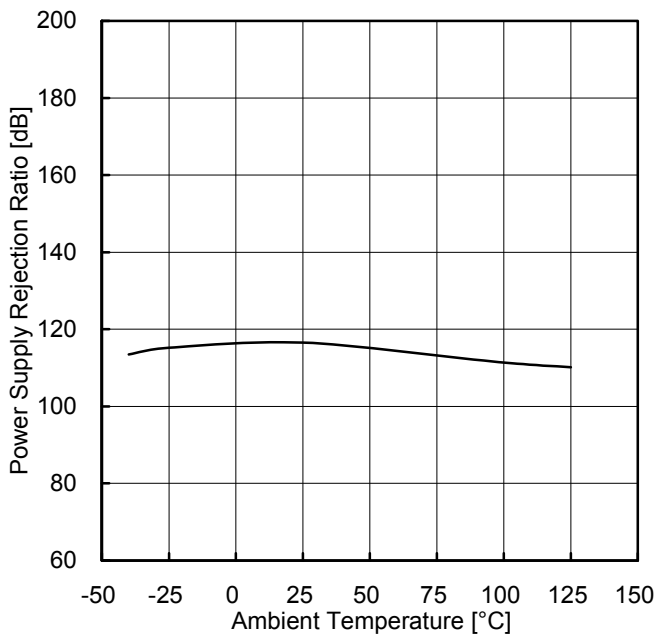

Figure 20. Power Supply Rejection Ratio vs Ambient Temperature

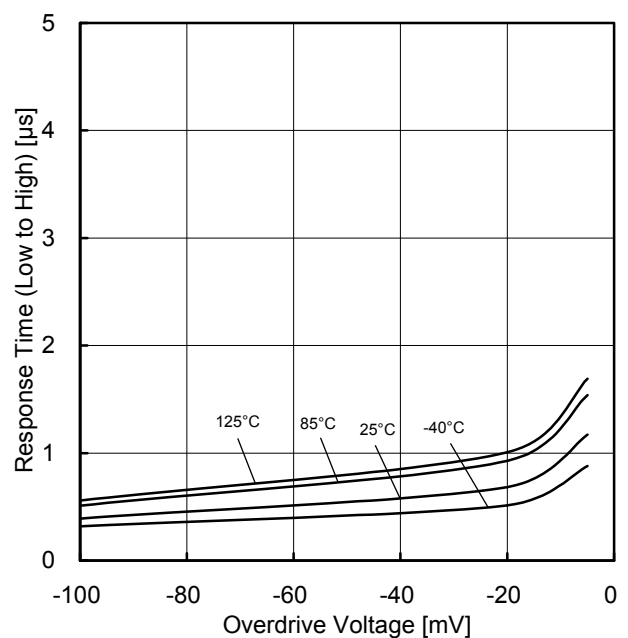

Figure 21. Response Time (Low to High) vs Overdrive Voltage ( $V_{CC^+}=5V$ ,  $V_{RL}=5V$ ,  $R_L=5.1k\Omega$ )

(\*)The above characteristics are measurements of typical sample, they are not guaranteed.

LM393 : -40°C to +85°C LM2903 : -40°C to +125°C

Typical Performance Curves - continued

OLM393xxx/LM2903xx

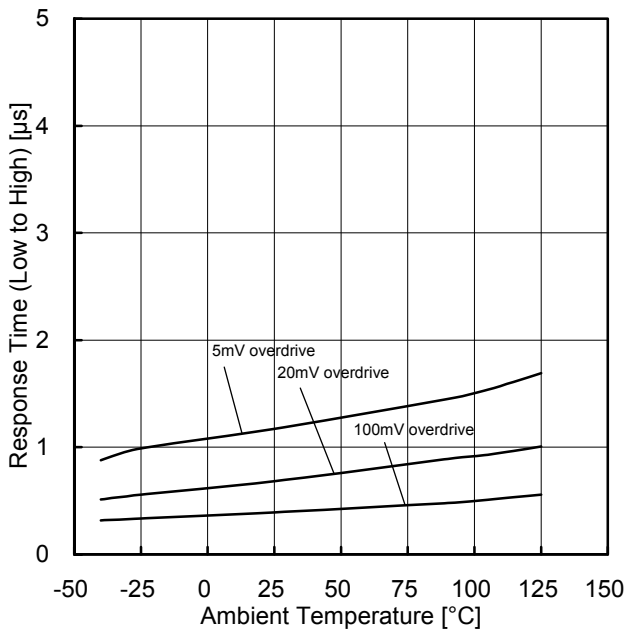

Figure 22. Response Time (Low to High) vs Ambient Temperature ( $V_{CC^+}=5V$ ,  $V_{RL}=5V$ ,  $R_L=5.1k\Omega$ )

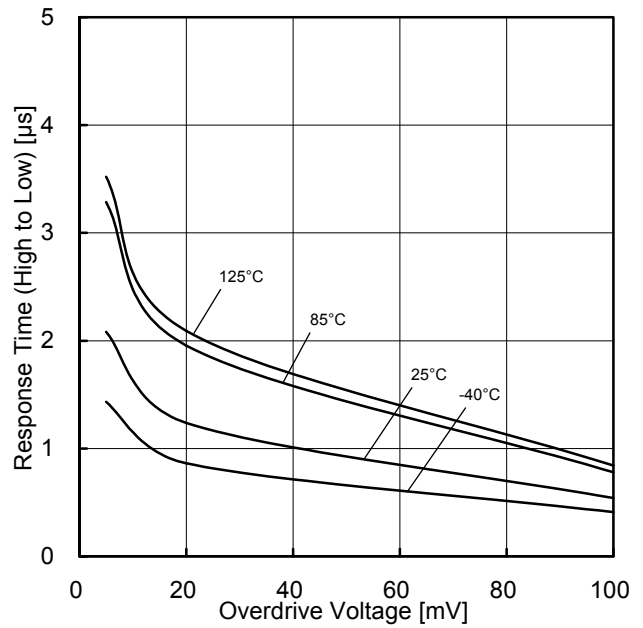

Figure 23. Response Time (High to Low) vs Overdrive Voltage ( $V_{CC^+}=5V$ ,  $V_{RL}=5V$ ,  $R_L=5.1k\Omega$ )

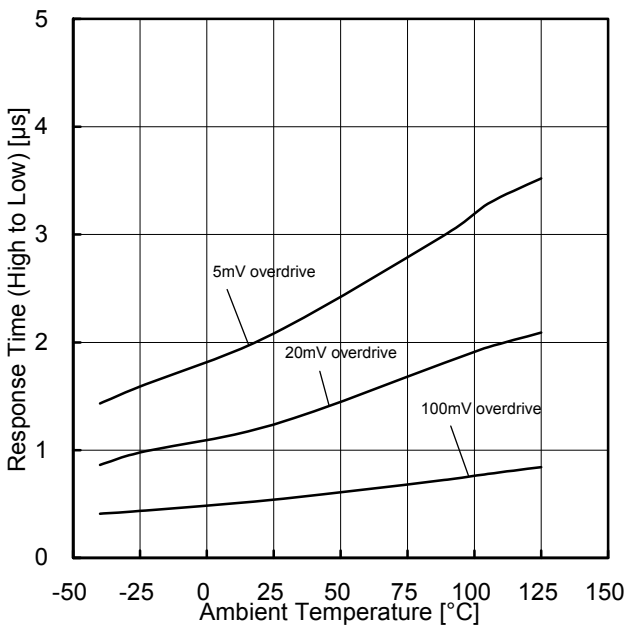

Figure 24. Response Time (High to Low) vs Ambient Temperature ( $V_{CC^+}=5V$ ,  $V_{RL}=5V$ ,  $R_L=5.1k\Omega$ )

(\*)The above characteristics are measurements of typical sample, they are not guaranteed.

LM393 : -40°C to +85°C LM2903 : -40°C to +125°C

Typical Performance Curves - continued

OLM339xx/LM2901xx

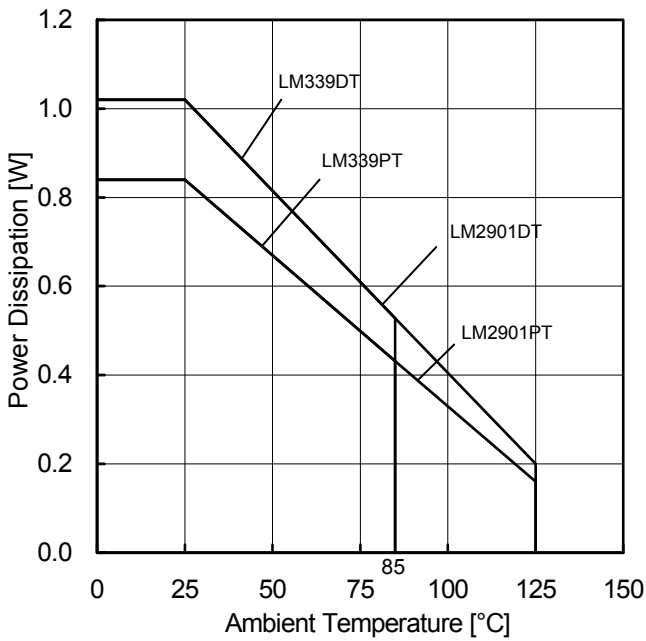

Figure 25. Power Dissipation vs Ambient Temperature (Derating Curve)

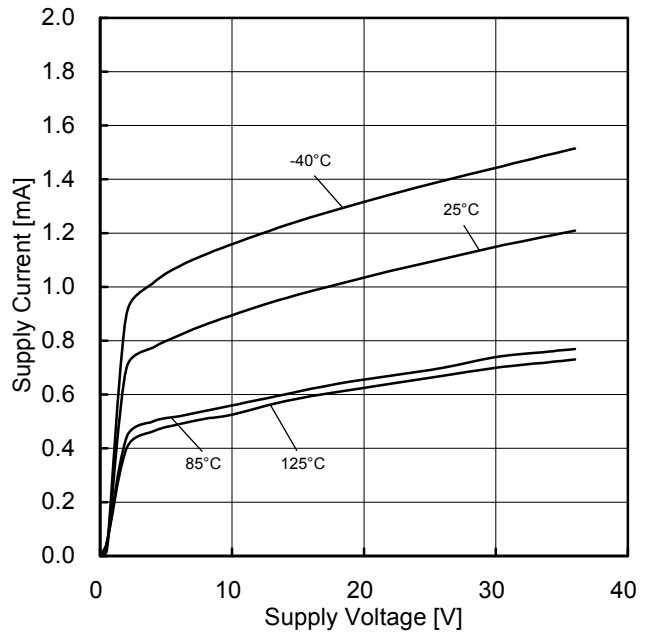

Figure 26. Supply Current vs Supply Voltage

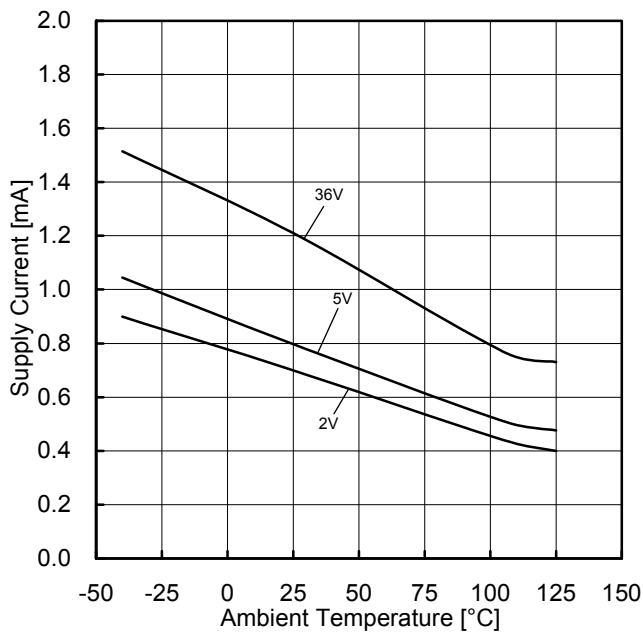

Figure 27. Supply Current vs Ambient Temperature

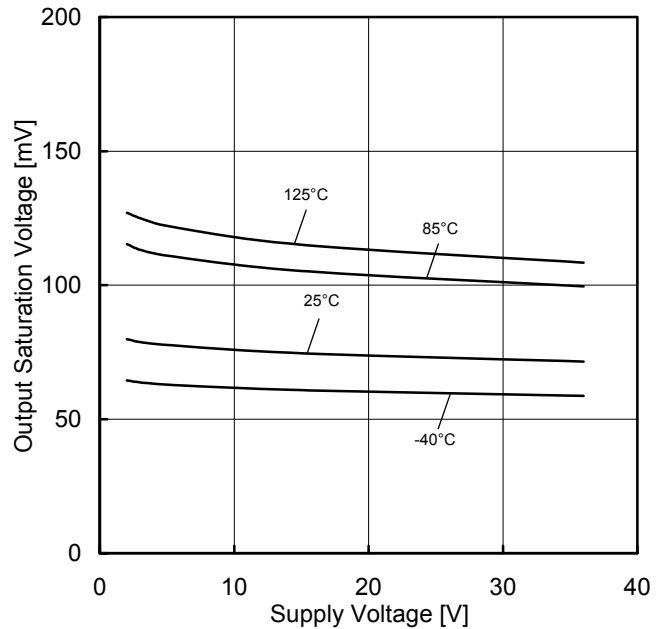

Figure 28. Output Saturation Voltage vs Supply Voltage (I<sub>SINK</sub>=4mA)

(\*)The above characteristics are measurements of typical sample, they are not guaranteed.

LM339 : -40°C to +85°C LM2901 : -40°C to +125°C

Typical Performance Curves - continued

OLM339xx/LM2901xx

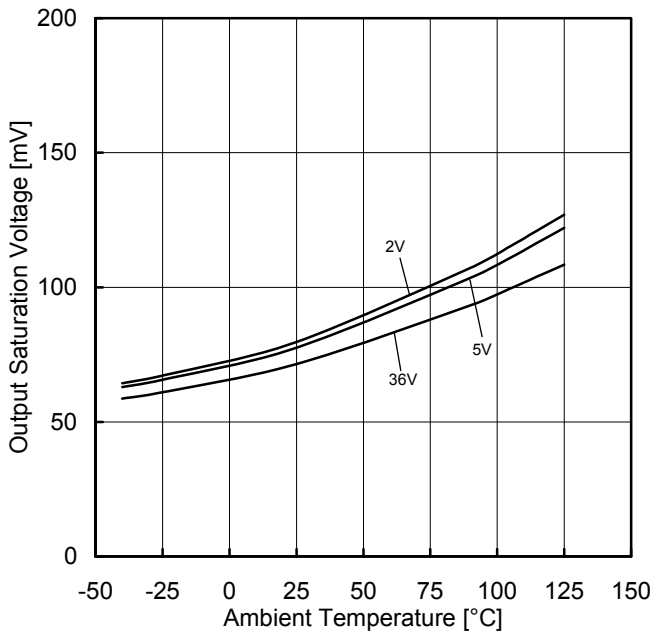

Figure 29. Output Saturation Voltage vs Ambient Temperature ( $I_{SINK}=4mA$ )

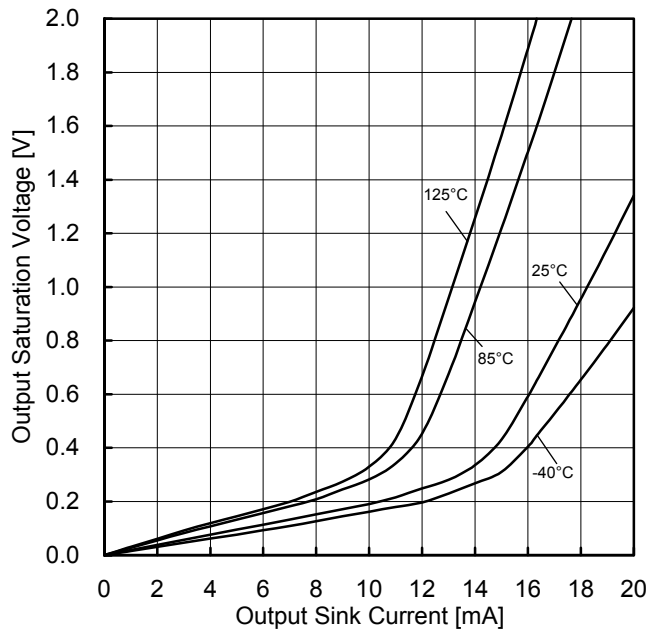

Figure 30. Output Saturation Voltage vs Output Sink Current ( $V_{CC+}=5V$ )

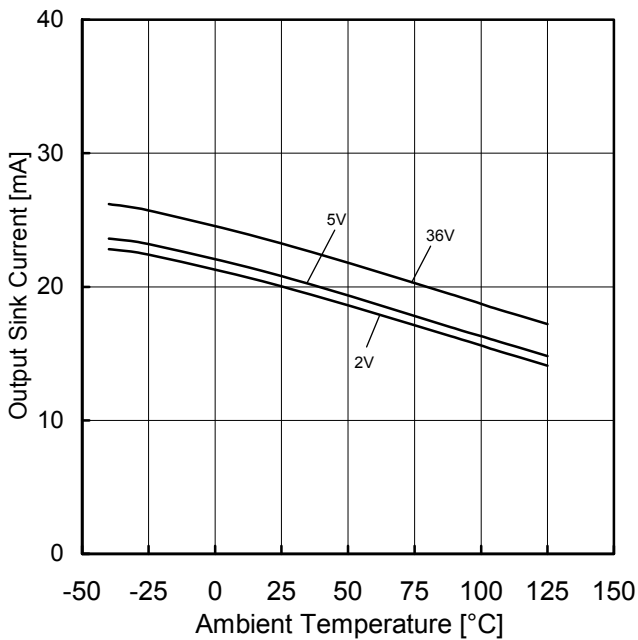

Figure 31. Output Sink Current vs Ambient Temperature ( $V_O=1.5V$ )

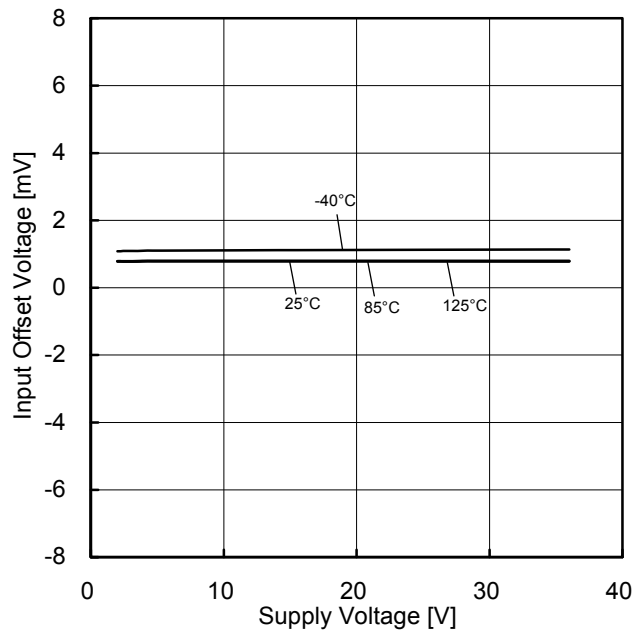

Figure 32. Input Offset Voltage vs Supply Voltage

(\*)The above characteristics are measurements of typical sample, they are not guaranteed.

LM339 : -40°C to +85°C LM2901 : -40°C to +125°C



Typical Performance Curves - continued

OLM339xx/LM2901xx

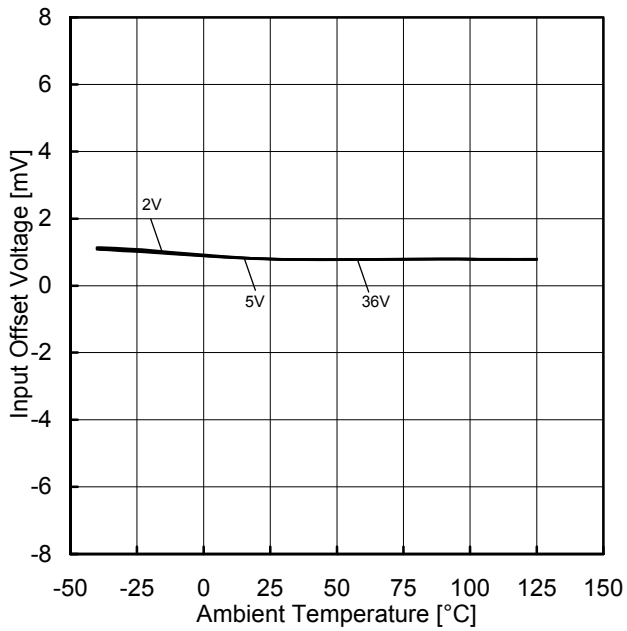

Figure 33. Input Offset Voltage vs Ambient Temperature

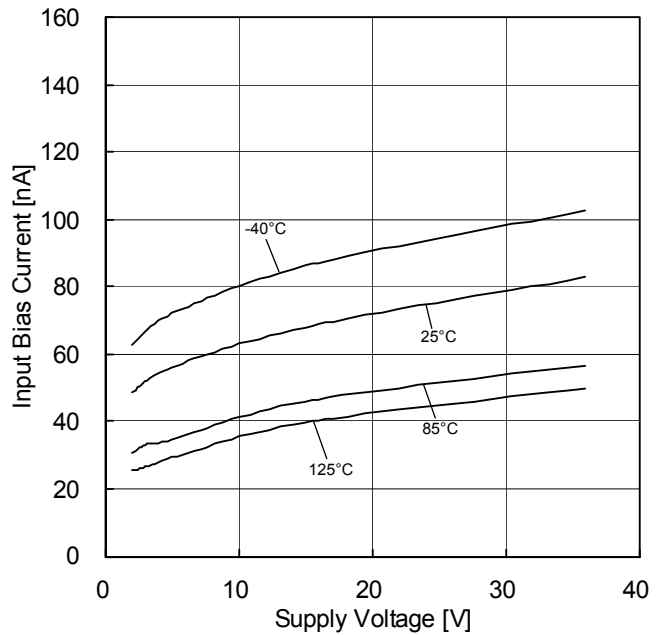

Figure 34. Input Bias Current vs Supply Voltage

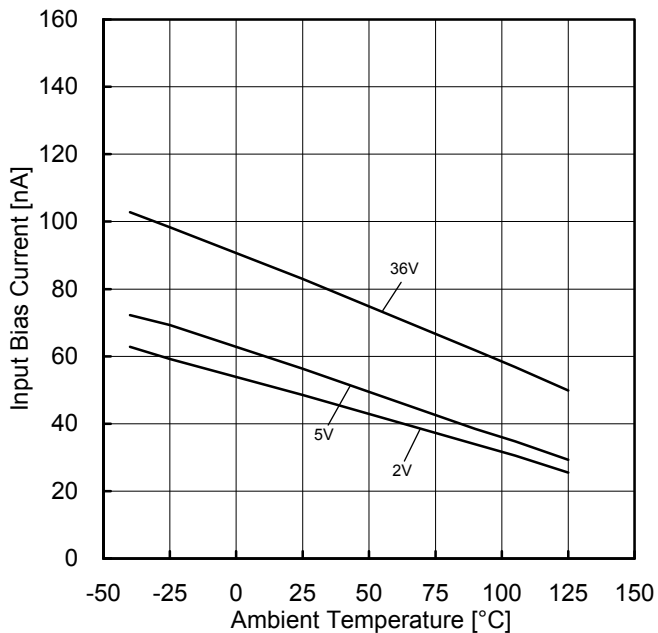

Figure 35. Input Bias Current vs Ambient Temperature

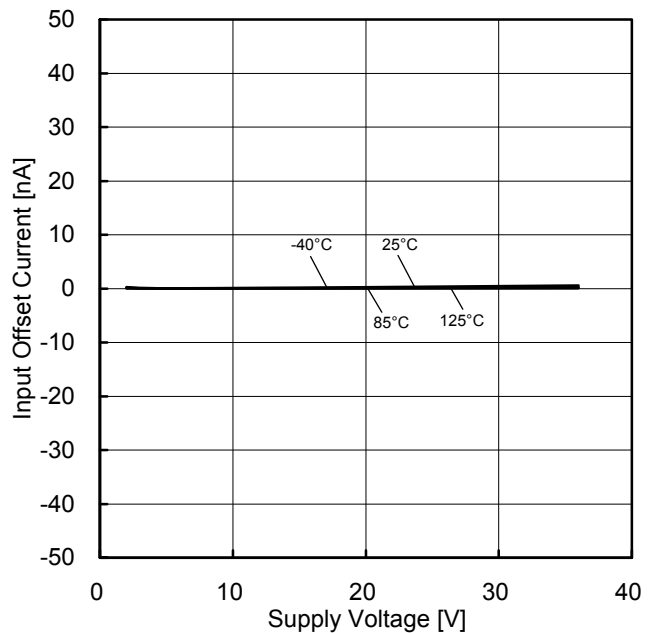

Figure 36. Input Offset Current vs Supply Voltage

(\*)The above characteristics are measurements of typical sample, they are not guaranteed.

LM339 : -40°C to +85°C LM2901 : -40°C to +125°C

Typical Performance Curves - continued

OLM339xx/LM2901xx

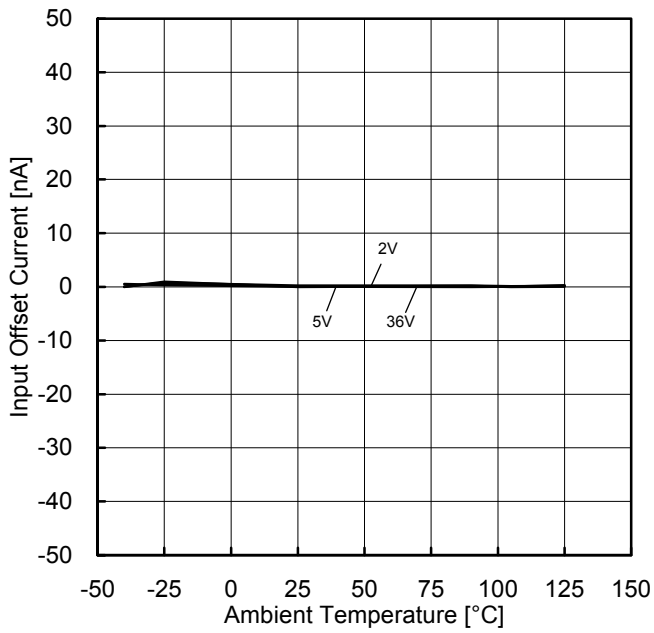

Figure 37. Input Offset Current vs Ambient Temperature

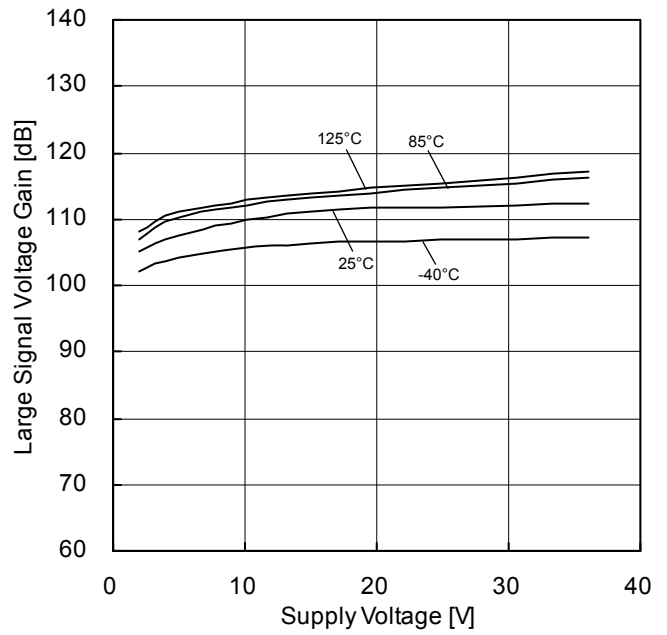

Figure 38. Large Signal Voltage Gain vs Supply Voltage

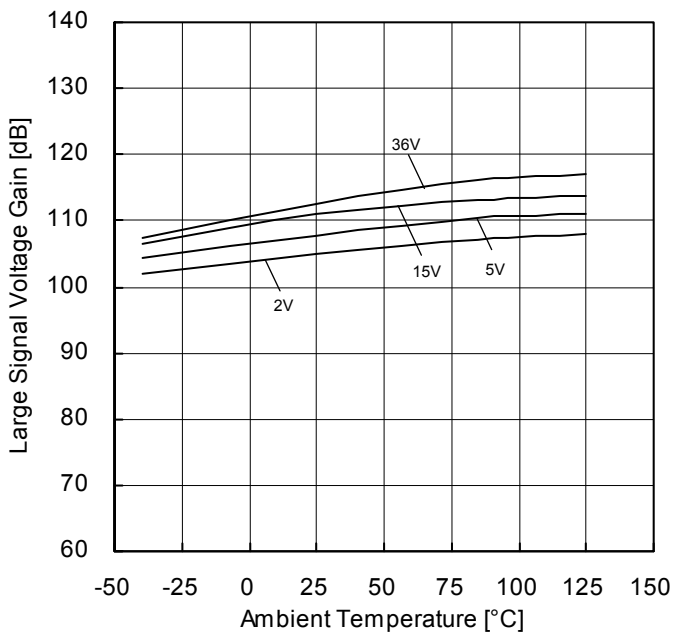

Figure 39. Large Signal Voltage Gain vs Ambient Temperature

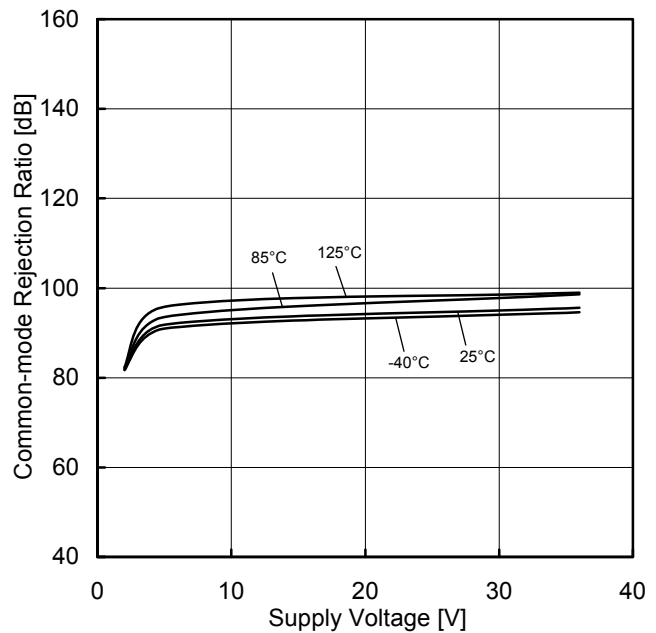

Figure 40. Common-mode Rejection Ratio vs Supply Voltage

(\*)The above characteristics are measurements of typical sample, they are not guaranteed.

LM339 : -40°C to +85°C LM2901 : -40°C to +125°C

Typical Performance Curves - continued

OLM339xx/LM2901xx

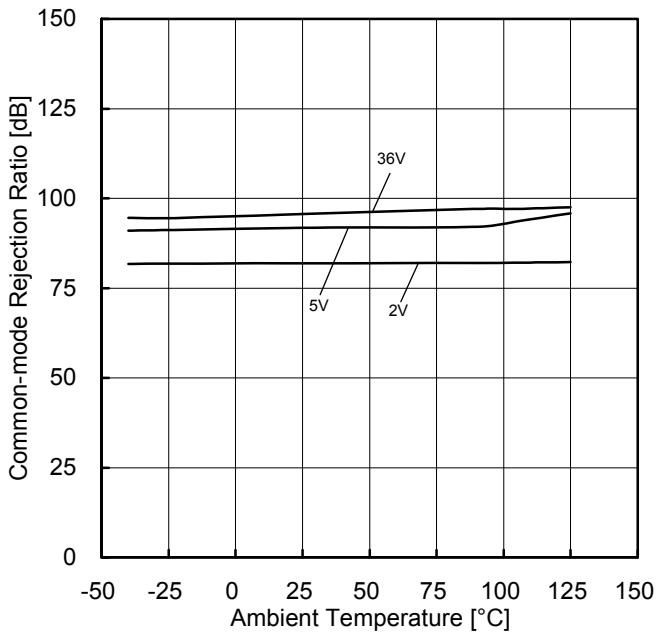

Figure 41. Common-mode Rejection Ratio vs Ambient Temperature

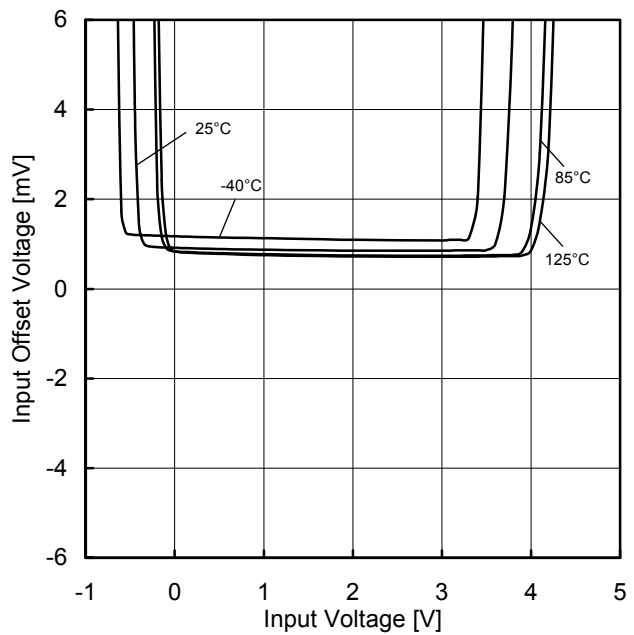

Figure 42. Input Offset Voltage vs Input Voltage (Vcc+=5V)

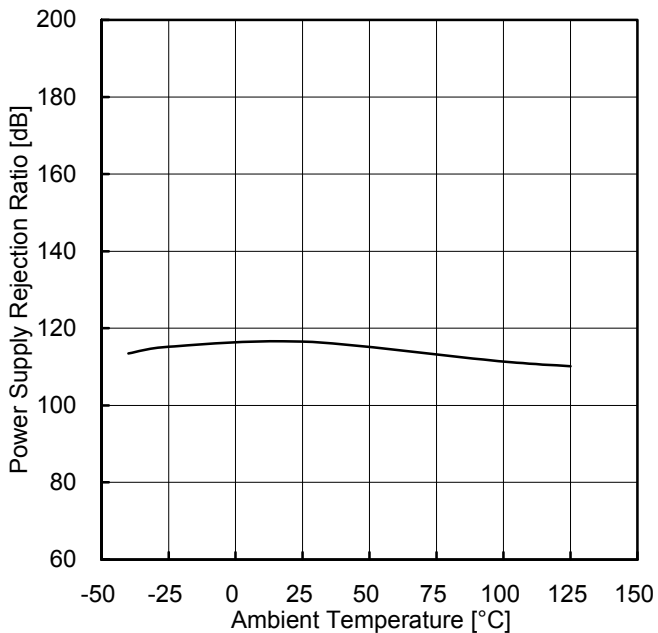

Figure 43. Power Supply Rejection Ratio vs Ambient Temperature

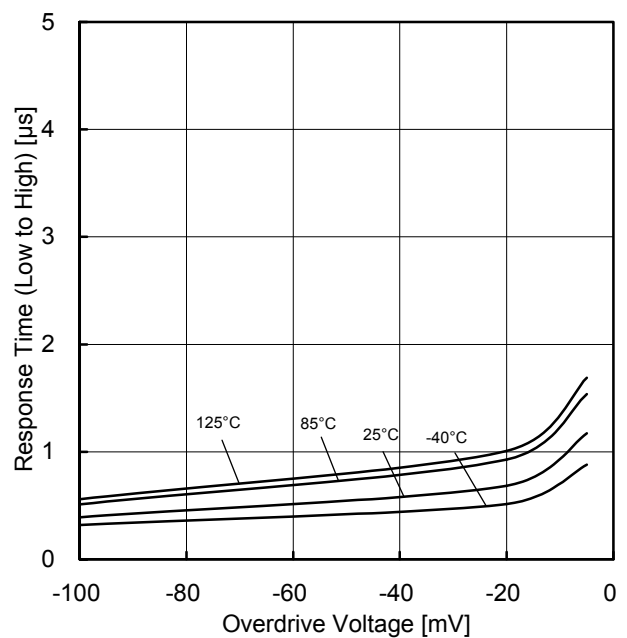

Figure 44. Response Time (Low to High) vs Overdrive Voltage (Vcc+=5V, V<sub>RL</sub>=5V, R<sub>L</sub>=5.1kΩ)

(\*)The above characteristics are measurements of typical sample, they are not guaranteed.

LM339 : -40°C to +85°C LM2901 : -40°C to +125°C

Typical Performance Curves - continued

OLM339xx/LM2901xx

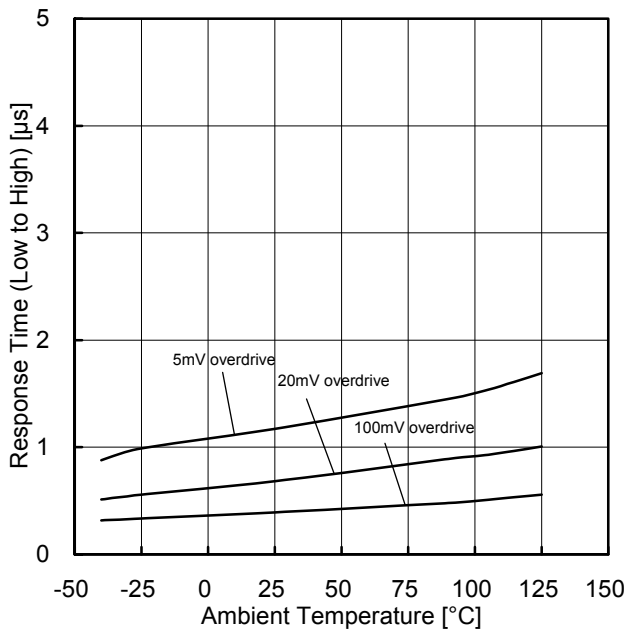

Figure 45. Response Time (Low to High) vs Ambient Temperature ( $V_{CC^+}=5V$ ,  $V_{RL}=5V$ ,  $R_L=5.1k\Omega$ )

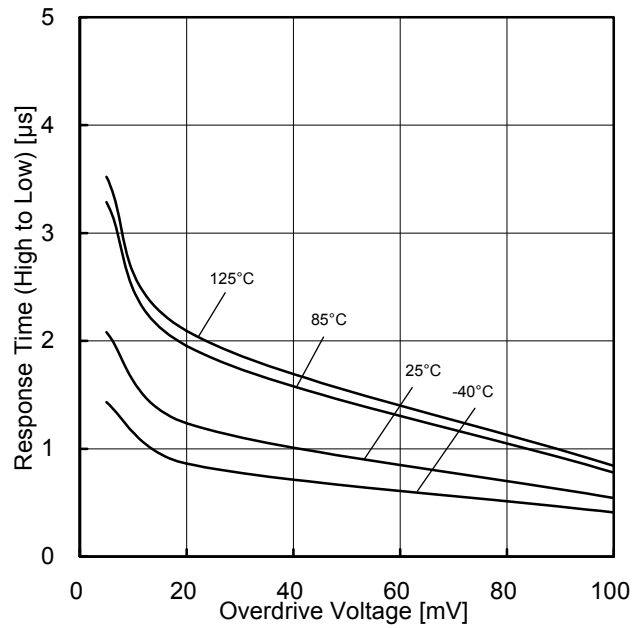

Figure 46. Response Time (High to Low) vs Overdrive Voltage ( $V_{CC^+}=5V$ ,  $V_{RL}=5V$ ,  $R_L=5.1k\Omega$ )

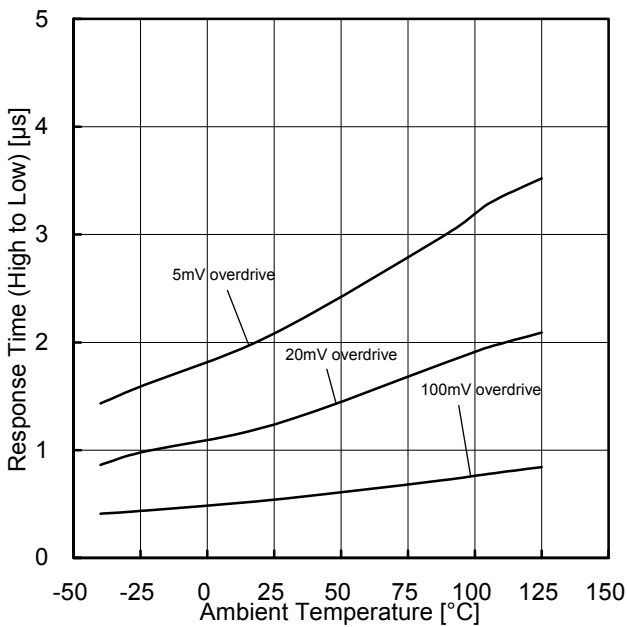

Figure 47. Response Time (High to Low) vs Ambient Temperature ( $V_{CC^+}=5V$ ,  $V_{RL}=5V$ ,  $R_L=5.1k\Omega$ )

(\*)The above characteristics are measurements of typical sample, they are not guaranteed.

LM339 : -40°C to +85°C LM2901 : -40°C to +125°C

Application Information

Measurement Circuit 1 NULL Method Measurement Condition

V<sub>CC</sub><sup>+</sup>, V<sub>CC</sub><sup>-</sup>, E<sub>K</sub>, V<sub>ICM</sub> unit : V

| Parameter                 | VF  | SW1 | SW2 | SW3 | V <sub>CC</sub> <sup>+</sup> | V <sub>CC</sub> <sup>-</sup> | E <sub>K</sub> | V <sub>ICM</sub> | Calculation |
|---------------------------|-----|-----|-----|-----|------------------------------|------------------------------|----------------|------------------|-------------|
| Input Offset Voltage      | VF1 | ON  | ON  | ON  | 5 to 30                      | 0                            | -1.4           | 0                | 1           |
| Input Offset Current      | VF2 | OFF | OFF | ON  | 5                            | 0                            | -1.4           | 0                | 2           |
| Input Bias Current        | VF3 | OFF | ON  | ON  | 5                            | 0                            | -1.4           | 0                | 3           |
|                           | VF4 | ON  | OFF |     | 5                            | 0                            | -1.4           | 0                |             |
| Large Signal Voltage Gain | VF5 | ON  | ON  | ON  | 15                           | 0                            | -1.4           | 0                | 4           |
|                           | VF6 |     |     |     | 15                           | 0                            | -11.4          | 0                |             |

-Calculation-

1. Input Offset Voltage (V<sub>IO</sub>)

$$V_{IO} = \frac{|V_{F1}|}{1+R_F/R_S} \text{ [V]}$$

2. Input Offset Current (I<sub>IO</sub>)

$$I_{IO} = \frac{|V_{F2}-V_{F1}|}{R_I \times (1+R_F/R_S)} \text{ [A]}$$

3. Input Bias Current (I<sub>B</sub>)

$$I_B = \frac{|V_{F4}-V_{F3}|}{2 \times R_I \times (1+R_F/R_S)} \text{ [A]}$$

4. Large Signal Voltage Gain (A<sub>V</sub>)

$$A_V = 20 \text{Log} \frac{10 \times (1+R_F/R_S)}{|V_{F5}-V_{F6}|} \text{ [dB]}$$

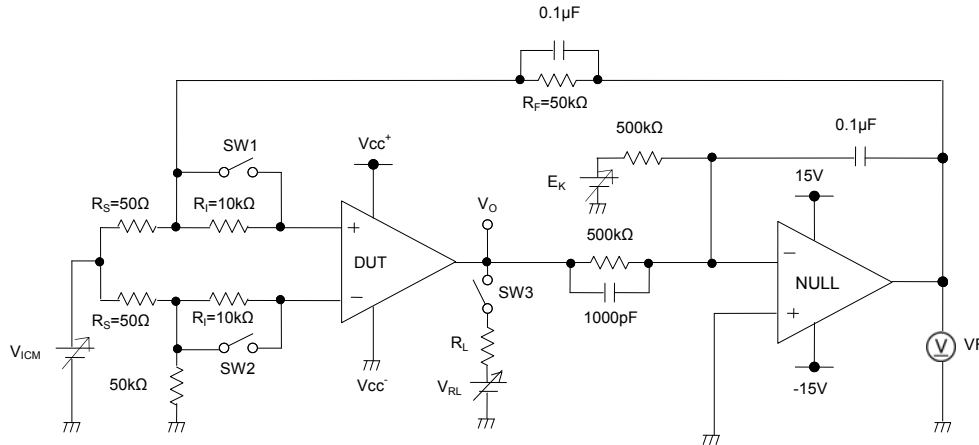

Figure 48. Measurement Circuit 1 (each Comparator)

**Application Information - continued**  
**Measurement Circuit 2: Switch Condition**

| SW No.                    |                  | SW1 | SW2 | SW3 | SW4 | SW5 | SW6 | SW7 |
|---------------------------|------------------|-----|-----|-----|-----|-----|-----|-----|
| Supply Current            | -                | ON  | OFF | ON  | OFF | OFF | OFF | OFF |
| Output Sink Current       | $V_O=1.5V$       | ON  | OFF | ON  | OFF | ON  | ON  | OFF |
| Output Saturation Voltage | $I_{SINK}=4mA$   | ON  | OFF | ON  | OFF | OFF | OFF | ON  |
| Output Leakage Current    | $V_O=36V$        | ON  | OFF | ON  | OFF | OFF | OFF | ON  |
| Response Time             | $R_L=5.1k\Omega$ | ON  | ON  | OFF | ON  | OFF | ON  | OFF |
|                           | $V_{RL}=5V$      |     |     |     |     |     |     |     |

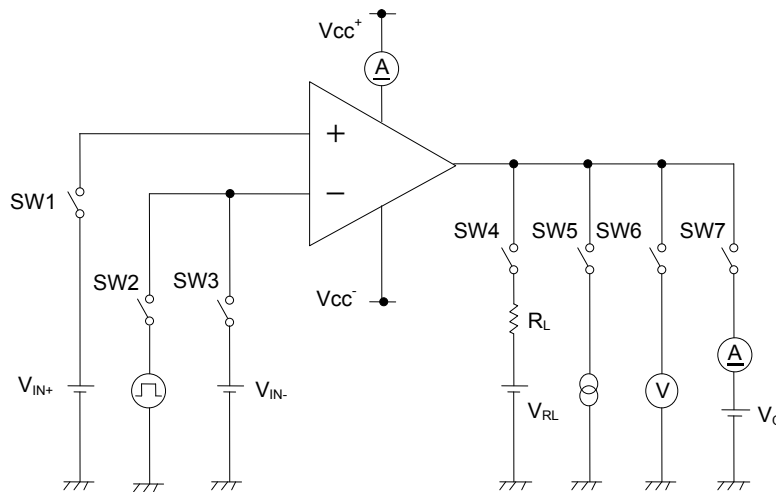

Figure 49. Measurement Circuit 2 (each Comparator)

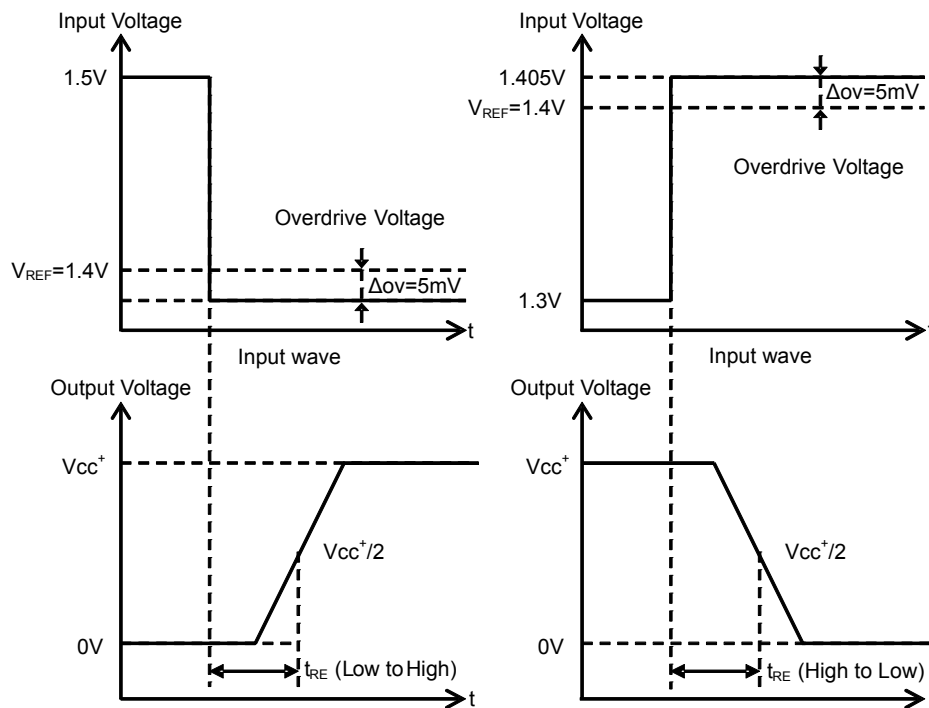
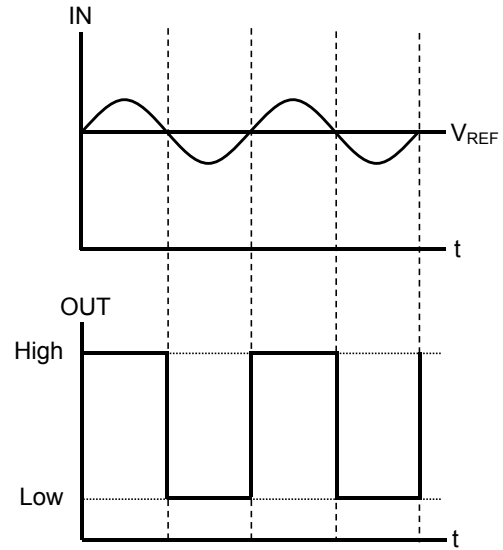
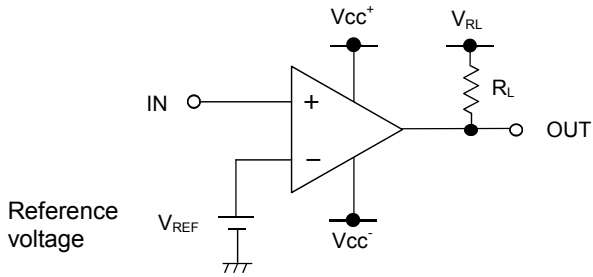

Figure 50. Response Time

Example of Circuit

○Reference voltage is  $V_{IN-}$ .



When the input voltage is bigger than reference voltage, output voltage is high. When the input voltage is smaller than reference voltage, output voltage is low.

○Reference voltage is  $V_{IN+}$ .

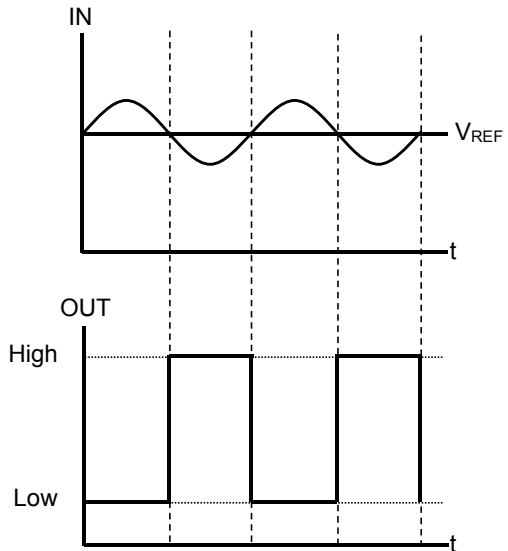
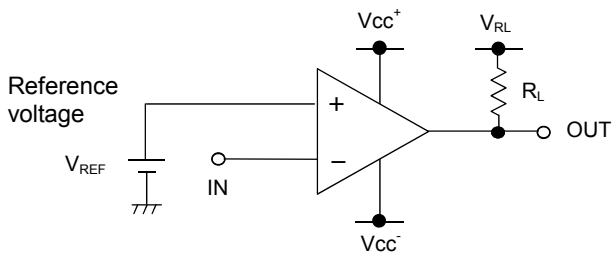

When the input voltage is smaller than reference voltage, output voltage is high. When the input voltage is bigger than reference voltage, output voltage is low.

**Power Dissipation**

Power dissipation (total loss) indicates the power that the IC can consume at  $T_A=25^\circ\text{C}$  (normal temperature). As the IC consumes power, it heats up, causing its temperature to be higher than the ambient temperature. The allowable temperature that the IC can accept is limited. This depends on the circuit configuration, manufacturing process, and consumable power.

Power dissipation is determined by the allowable temperature within the IC (maximum junction temperature) and the thermal resistance of the package used (heat dissipation capability). Maximum junction temperature is typically equal to the maximum storage temperature. The heat generated through the consumption of power by the IC radiates from the mold resin or lead frame of the package. Thermal resistance, represented by the symbol  $\theta_{JA}^\circ\text{C/W}$ , indicates this heat dissipation capability. Similarly, the temperature of an IC inside its package can be estimated by thermal resistance.

Figure 51(a) shows the model of the thermal resistance of a package. The equation below shows how to compute for the Thermal resistance ( $\theta_{JA}$ ), given the ambient temperature ( $T_A$ ), maximum junction temperature ( $T_{Jmax}$ ), and power dissipation ( $P_D$ ).

$$\theta_{JA} = (T_{Jmax} - T_A) / P_D \quad ^\circ\text{C/W}$$

The Derating curve in Figure 51(b) indicates the power that the IC can consume with reference to ambient temperature. Power consumption of the IC begins to attenuate at certain temperatures. This gradient is determined by Thermal resistance ( $\theta_{JA}$ ), which depends on the chip size, power consumption, package, ambient temperature, package condition, wind velocity, etc. This may also vary even when the same package is used. Thermal reduction curve indicates a reference value measured at a specified condition. Figure 51(c) and (d) shows an example of the derating curve for LM393xxx, LM2903xx, LM339xx, and LM2901xx.

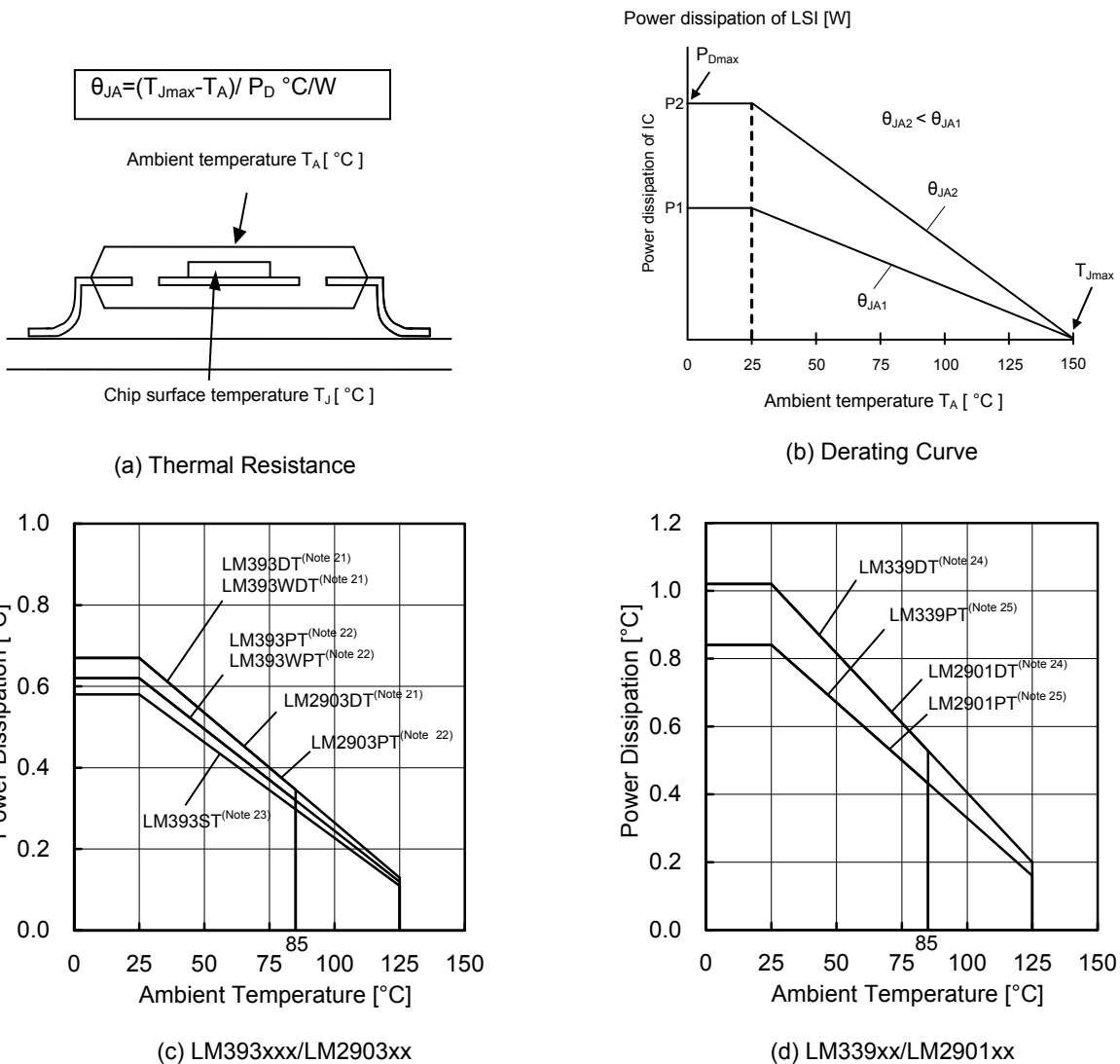

| (Note 21) | (Note 22) | (Note 23) | (Note 24) | (Note 25) | Unit  |
|-----------|-----------|-----------|-----------|-----------|-------|
| 5.4       | 5.0       | 4.7       | 8.2       | 6.8       | mW/°C |

When using the unit above  $T_A=25^\circ\text{C}$ , subtract the value above per Celsius degree.  
 Power dissipation is the value when FR4 glass epoxy board 70mm x 70mm x 1.6mm (cooper foil area below 3%) is mounted.

Figure 51. Thermal Resistance and Derating Curve



## Operational Notes

- 1. Reverse Connection of Power Supply**

Connecting the power supply in reverse polarity can damage the IC. Take precautions against reverse polarity when connecting the power supply, such as mounting an external diode between the power supply and the IC's power supply pins.
- 2. Power Supply Lines**

Design the PCB layout pattern to provide low impedance ground and supply lines. Separate the ground and supply lines of the digital and analog blocks to prevent noise in the ground and supply lines of the digital block from affecting the analog block. Furthermore, connect a capacitor to ground at all power supply pins. Consider the effect of temperature and aging on the capacitance value when using electrolytic capacitors.
- 3. Ground Voltage**

Ensure that no pins are at a voltage below that of the ground pin at any time, even during transient condition.
- 4. Ground Wiring Pattern**

When using both small-signal and large-current ground traces, the two ground traces should be routed separately but connected to a single ground at the reference point of the application board to avoid fluctuations in the small-signal ground caused by large currents. Also ensure that the ground traces of external components do not cause variations on the ground voltage. The power supply and ground lines must be as short and thick as possible to reduce line impedance.
- 5. Thermal Consideration**

Should by any chance the power dissipation rating be exceeded, the rise in temperature of the chip may result in deterioration of the properties of the chip. The absolute maximum rating of the  $P_D$  stated in this specification is when the IC is mounted on a 70mm x 70mm x 1.6mm glass epoxy board. In case of exceeding this absolute maximum rating, increase the board size and copper area to prevent exceeding the  $P_D$  rating.
- 6. Recommended Operating Conditions**

These conditions represent a range within which the expected characteristics of the IC can be approximately obtained. The electrical characteristics are guaranteed under the conditions of each parameter.
- 7. Inrush Current**

When power is first supplied to the IC, it is possible that the internal logic may be unstable and inrush current may flow instantaneously due to the internal powering sequence and delays, especially if the IC has more than one power supply. Therefore, give special consideration to power coupling capacitance, power wiring, width of ground wiring, and routing of connections.
- 8. Operation Under Strong Electromagnetic Field**

Operating the IC in the presence of a strong electromagnetic field may cause the IC to malfunction.
- 9. Testing on Application Boards**

When testing the IC on an application board, connecting a capacitor directly to a low-impedance output pin may subject the IC to stress. Always discharge capacitors completely after each process or step. The IC's power supply should always be turned off completely before connecting or removing it from the test setup during the inspection process. To prevent damage from static discharge, ground the IC during assembly and use similar precautions during transport and storage.
- 10. Inter-pin Short and Mounting Errors**

Ensure that the direction and position are correct when mounting the IC on the PCB. Incorrect mounting may result in damaging the IC. Avoid nearby pins being shorted to each other especially to ground, power supply and output pin. Inter-pin shorts could be due to many reasons such as metal particles, water droplets (in very humid environment) and unintentional solder bridge deposited in between pins during assembly to name a few.

## Operational Notes – continued

## 11. Regarding Input Pins of the IC

This monolithic IC contains P+ isolation and P substrate layers between adjacent elements in order to keep them isolated. P-N junctions are formed at the intersection of the P layers with the N layers of other elements, creating a parasitic diode or transistor. For example (refer to figure below):

- When  $GND > Pin\ A$  and  $GND > Pin\ B$ , the P-N junction operates as a parasitic diode.
- When  $GND > Pin\ B$ , the P-N junction operates as a parasitic transistor.

Parasitic diodes inevitably occur in the structure of the IC. The operation of parasitic diodes can result in mutual interference among circuits, operational faults, or physical damage. Therefore, conditions that cause these diodes to operate, such as applying a voltage lower than the GND voltage to an input pin (and thus to the P substrate) should be avoided.

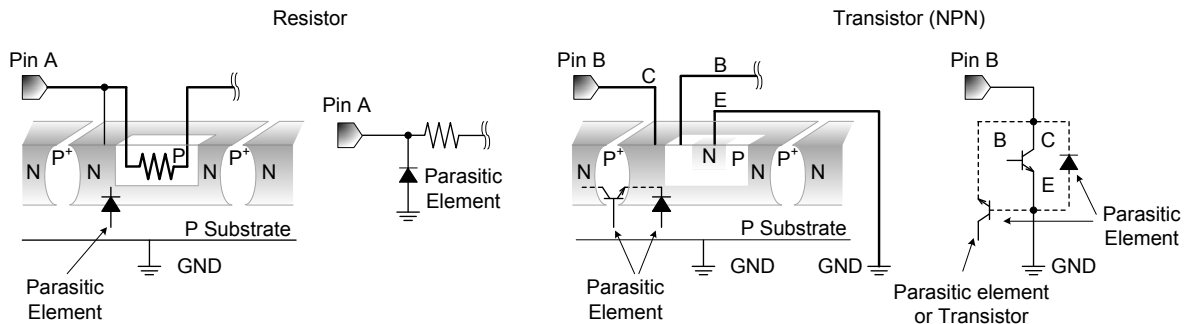

Figure 52. Example of Monolithic IC Structure

## 12. Unused Circuits

When there are unused circuits it is recommended that they be connected as in Figure 53, setting the non-inverting input pin to a potential within the in-phase input voltage range ( $V_{ICM}$ ).

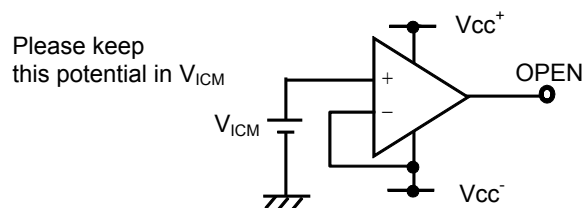

Figure 53. Disable Circuit Example

## 13. Input Voltage

Applying  $V_{cc}^- + 36V$  to the input pin is possible without causing deterioration of the electrical characteristics or destruction, regardless of the supply voltage. However, this does not ensure normal circuit operation. Please note that the circuit operates normally only when the input voltage is within the common-mode input voltage range of the electric characteristics.

## 14. Power Supply (single/dual)

The comparator operates when the specified voltage supplied is between  $V_{cc}^+$  and  $V_{cc}^-$ . Therefore, the single supply comparator can be used as a dual supply comparator as well.

## 15. Terminal short-circuits

When the output and  $V_{cc}^+$  pins are shorted, excessive output current may flow, resulting in undue heat generation and, subsequently, destruction.

## 16. IC Handling

Applying mechanical stress to the IC by deflecting or bending the board may cause fluctuations in the electrical characteristics due to piezo resistance effects.

Physical Dimension, Tape and Reel information

|              |                      |
|--------------|----------------------|
| Package Name | SO Package8 (SOP-J8) |
|--------------|----------------------|

4.9±0.2  
Max 5.25 (include. BURR)

6.0±0.3  
3.9±0.2  
0.545

8 7 6 5  
1 2 3 4

$4^{\circ} \begin{matrix} +6^{\circ} \\ -4^{\circ} \end{matrix}$   
0.45MIN  
0.2±0.1

1.375±0.1  
0.175  
1.27  
0.42±0.1

0.1 S

(UNIT : mm)

PKG : SOP-J8

Drawing No. EX111-5002

<Tape and Reel information>

|                   |   |
|-------------------|---|
| Tape              | Embossed carrier tape   |
| Quantity          | 2500pcs   |
| Direction of feed | E2<br>(The direction is the 1pin of product is at the upper left when you hold reel on the left hand and you pull out the tape on the right hand) |

\*Order quantity needs to be multiple of the minimum quantity.

Physical Dimension, Tape and Reel Information – continued

|              |                   |
|--------------|-------------------|
| Package Name | TSSOP8 (TSSOP-B8) |
|--------------|-------------------|

3.0±0.1  
(Max 3.35 (include BURR))

6.4±0.2  
4.4±0.1

0.525

1PIN MARK

4°±4°

0.5±0.15  
1.0±0.2

0.145 <sup>+0.05</sup>/<sub>-0.03</sub>

S

1.2MAX  
1.0±0.05  
0.1±0.05

0.65

0.245 <sup>+0.05</sup>/<sub>-0.04</sub>

0.08 S  
0.08 M

(UNIT : mm)  
PKG : TSSOP-B8  
Drawing No. EX165-5002

<Tape and Reel information>

|                   |   |
|-------------------|---|
| Tape              | Embossed carrier tape   |
| Quantity          | 3000pcs   |
| Direction of feed | E2<br>(The direction is the 1pin of product is at the upper left when you hold reel on the left hand and you pull out the tape on the right hand) |

Reel

1pin

Direction of feed

\*Order quantity needs to be multiple of the minimum quantity.

Physical Dimension, Tape and Reel Information – continued

|              |                      |
|--------------|----------------------|
| Package Name | Mini SO8 (TSSOP-B8J) |
|--------------|----------------------|

3.0±0.1  
(Max 3.35 (include BURR))  
4.9±0.2  
3.0±0.1  
0.525  
1PIN MARK

4°±4°  
0.45±0.15  
0.95±0.2  
0.145 <sup>+0.05</sup>/<sub>-0.03</sub>

1.1MAX  
0.85±0.05  
0.1±0.05  
0.65  
0.32 <sup>+0.05</sup>/<sub>-0.04</sub>  
0.08 S  
0.08 M

(UNIT : mm)  
PKG : TSSOP-B8J  
Drawing No. EX164-5002

<Tape and Reel information>

|                   |   |
|-------------------|---|
| Tape              | Embossed carrier tape   |
| Quantity          | 2500pcs   |
| Direction of feed | E2<br>(The direction is the 1pin of product is at the upper left when you hold reel on the left hand and you pull out the tape on the right hand) |

Reel      1pin      Direction of feed

\* Order quantity needs to be multiple of the minimum quantity.

Physical Dimension, Tape and Reel Information – continued

|              |                        |
|--------------|------------------------|
| Package Name | SO Package14 (SOP-J14) |
|--------------|------------------------|

(UNIT : mm)  
 PKG : SOP-J14  
 Drawing No. EX126-5002-1

<Tape and Reel information>

|                   |   |
|-------------------|---|
| Tape              | Embossed carrier tape   |
| Quantity          | 2500pcs   |
| Direction of feed | E2<br>(The direction is the 1pin of product is at the upper left when you hold reel on the left hand and you pull out the tape on the right hand) |

\*Order quantity needs to be multiple of the minimum quantity.

Physical Dimension, Tape and Reel Information – continued

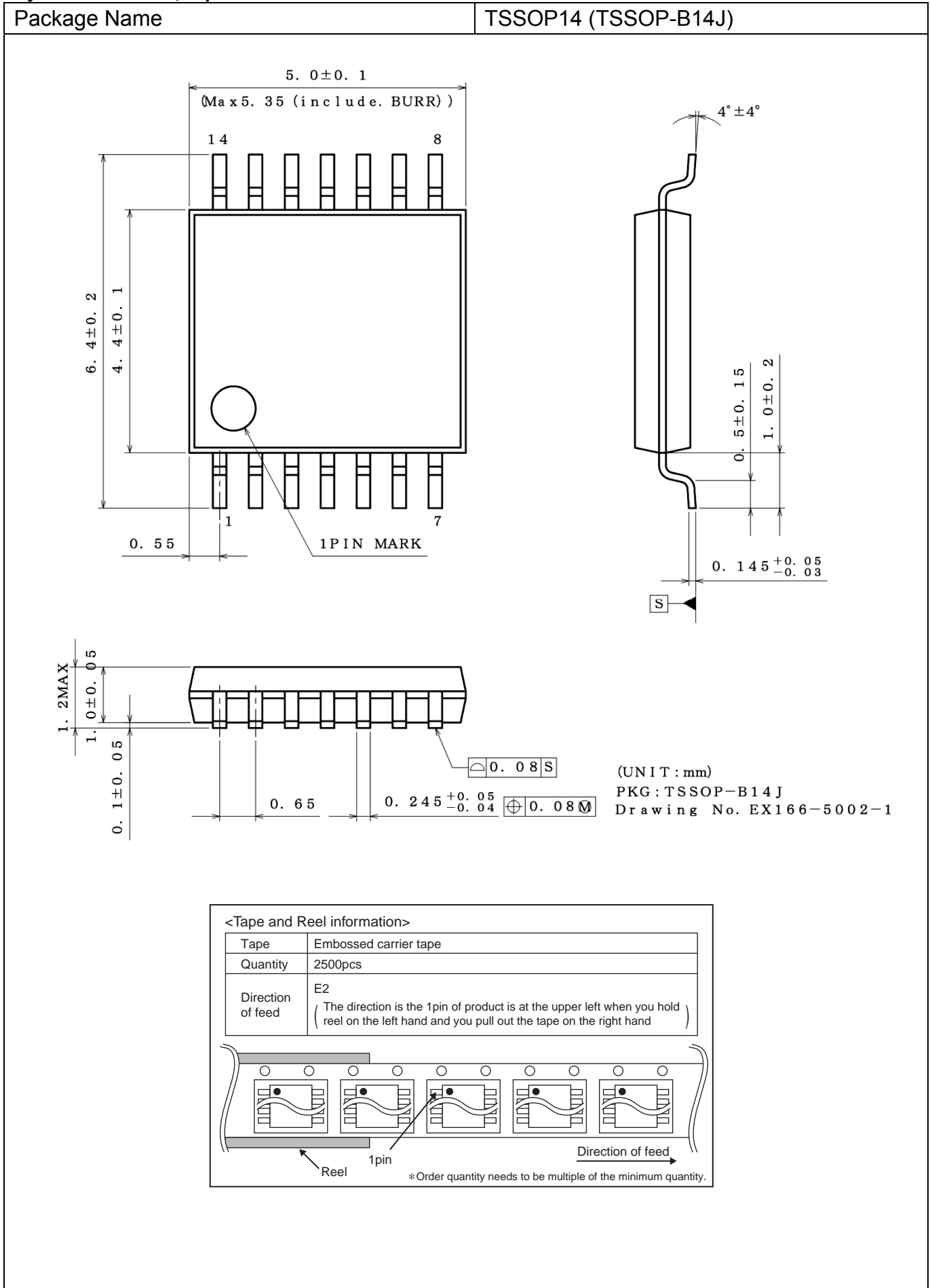

Ordering Information

L M x x x x x x T

| Part Number | ESD Tolerance applicable | Package type    | Packaging and forming specification |
|-------------|--------------------------|-----------------|-------------------------------------|
| LM393DT     | W : 2kV                  | D : S.O package | T: Embossed tape and reel           |
| LM393WDT    | None : Normal            | P : SSOP        |                                     |
| LM393PT     |                          | S : Mini SO     |                                     |
| LM393WPT    |                          |                 |                                     |
| LM393ST     |                          |                 |                                     |
| LM339DT     |                          |                 |                                     |
| LM339PT     |                          |                 |                                     |
| LM2903DT    |                          |                 |                                     |
| LM2903PT    |                          |                 |                                     |
| LM2901DT    |                          |                 |                                     |
| LM2901PT    |                          |                 |                                     |

Line-up

| Topr            | Channels | ESD     | Package      |              | Orderable Part Number |
|-----------------|----------|---------|--------------|--------------|-----------------------|
| -40°C to +85°C  | 2        | Normal  | SO Package8  | Reel of 2500 | LM393DT               |
|                 |          |         | TSSOP8       | Reel of 2500 | LM393PT               |
|                 |          |         | Mini SO8     | Reel of 2500 | LM393ST               |
|                 | 4        | 2kV     | SO Package8  | Reel of 2500 | LM393WDT              |
|                 |          |         | TSSOP8       | Reel of 2500 | LM393WPT              |
|                 |          |         | SO Package14 | Reel of 2500 | LM339DT               |
| -40°C to +125°C | 2        | Normal  | TSSOP14      | Reel of 2500 | LM339PT               |
|                 |          |         | SO Package8  | Reel of 2500 | LM2903DT              |
|                 | 4        |         | TSSOP8       | Reel of 2500 | LM2903PT              |
|                 |          |         | SO Package14 | Reel of 2500 | LM2901DT              |
|                 |          | TSSOP14 | Reel of 2500 | LM2901PT     |                       |



Marking Diagram

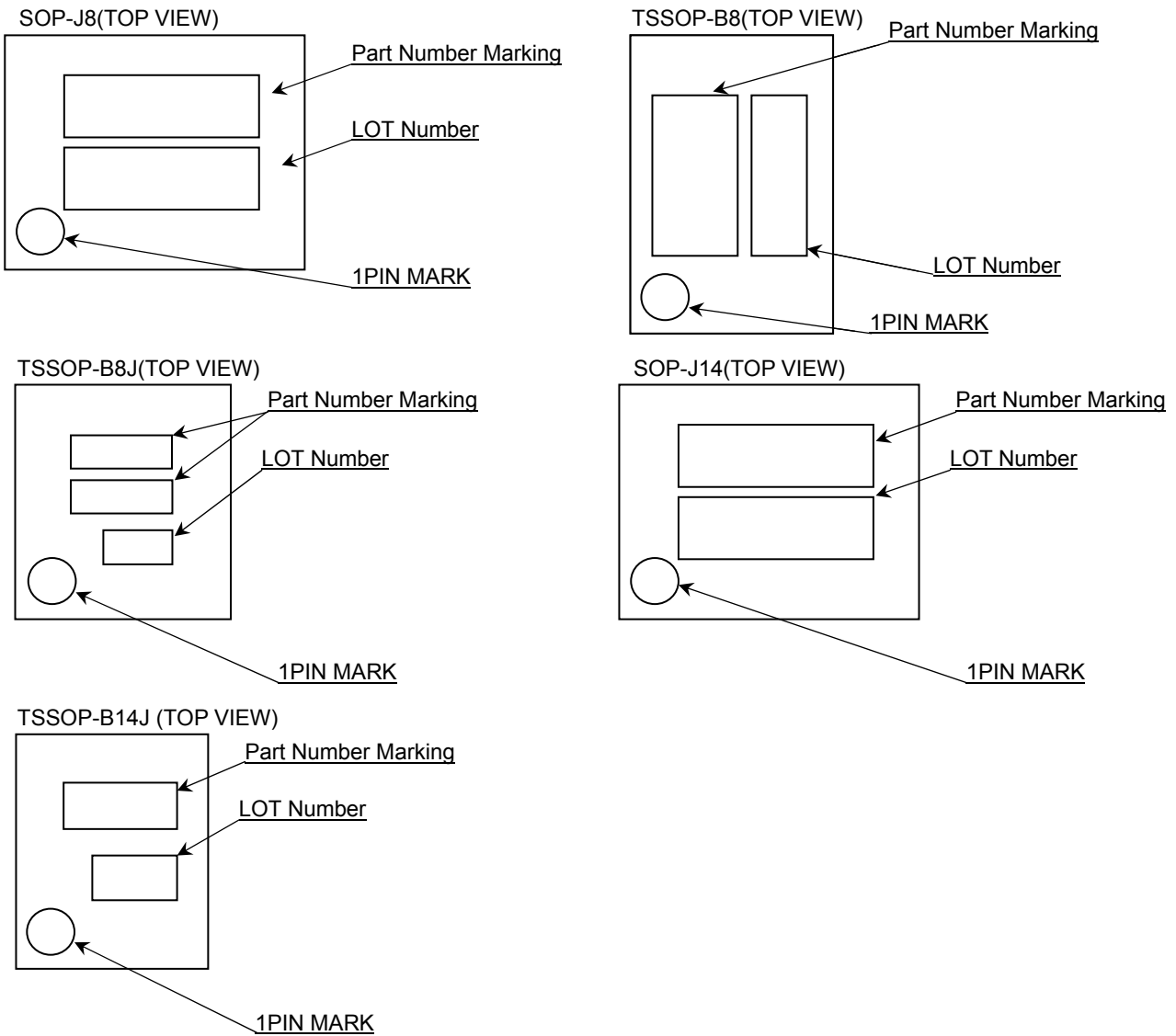

| Product Name |     | Package Type           | Marking |
|--------------|-----|------------------------|---------|
| LM393        | DT  | SO Package8 (SOP-J8)   | 393     |
|              | PT  | TSSOP8 (TSSPO-B8)      |         |
|              | ST  | Mini SO8 (TSSOP-B8J)   |         |
|              | WDT | SO Package8 (SOP-J8)   |         |
|              | WPT | TSSOP8 (TSSPO-B8)      |         |
| LM339        | DT  | SO Package14 (SOP-J14) | 339     |
|              | PT  | TSSOP14 (TSSOP-B14J)   |         |
| LM2903       | DT  | SO Package8 (SOP-J8)   | 2903    |
|              | PT  | TSSOP8 (TSSPO-B8)      |         |
| LM2901       | DT  | SO Package14 (SOP-J14) | 2901    |
|              | PT  | TSSOP14 (TSSOP-B14J)   |         |

Land Pattern Data

All dimensions in mm

| PKG  | Land pitch<br>e | Land space<br>MIE | Land length<br>≥ℓ 2 | Land width<br>b2 |
|--|-----------------|-------------------|---------------------|------------------|
| SO Package8 (SOP-J8)<br>SO Package14 (SOP-J14) | 1.27            | 3.90              | 1.35                | 0.76             |
| TSSOP8 (TSSPO-B8)<br>TSSOP14 (TSSOP-B14J)      | 0.65            | 4.60              | 1.20                | 0.35             |
| Mini SO8 (TSSOP-B8J)                           | 0.65            | 3.20              | 1.15                | 0.35             |

SOP-J8, TSSOP-B8, TSSOP-B8J,  
SOP-J14, TSSOP-B14J

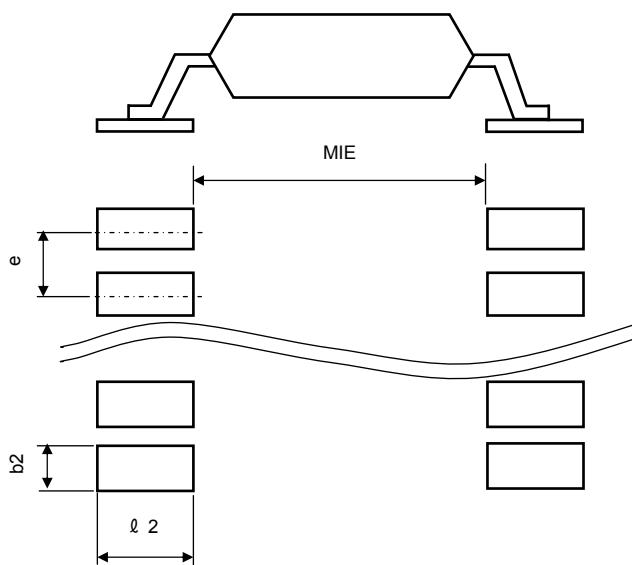

Revision History

| Date        | Revision | Changes     |
|-------------|----------|-------------|
| 6.July.2015 | 001      | New Release |

# Notice

## Precaution on using ROHM Products

- Our Products are designed and manufactured for application in ordinary electronic equipments (such as AV equipment, OA equipment, telecommunication equipment, home electronic appliances, amusement equipment, etc.). If you intend to use our Products in devices requiring extremely high reliability (such as medical equipment <sup>(Note 1)</sup>, transport equipment, traffic equipment, aircraft/spacecraft, nuclear power controllers, fuel controllers, car equipment including car accessories, safety devices, etc.) and whose malfunction or failure may cause loss of human life, bodily injury or serious damage to property ("Specific Applications"), please consult with the ROHM sales representative in advance. Unless otherwise agreed in writing by ROHM in advance, ROHM shall not be in any way responsible or liable for any damages, expenses or losses incurred by you or third parties arising from the use of any ROHM's Products for Specific Applications.

(Note1) Medical Equipment Classification of the Specific Applications

| JAPAN     | USA       | EU         | CHINA     |
|-----------|-----------|------------|-----------|
| CLASS III | CLASS III | CLASS II b | CLASS III |
| CLASS IV  |           | CLASS III  |           |

- ROHM designs and manufactures its Products subject to strict quality control system. However, semiconductor products can fail or malfunction at a certain rate. Please be sure to implement, at your own responsibilities, adequate safety measures including but not limited to fail-safe design against the physical injury, damage to any property, which a failure or malfunction of our Products may cause. The following are examples of safety measures:
  - Installation of protection circuits or other protective devices to improve system safety
  - Installation of redundant circuits to reduce the impact of single or multiple circuit failure
- Our Products are designed and manufactured for use under standard conditions and not under any special or extraordinary environments or conditions, as exemplified below. Accordingly, ROHM shall not be in any way responsible or liable for any damages, expenses or losses arising from the use of any ROHM's Products under any special or extraordinary environments or conditions. If you intend to use our Products under any special or extraordinary environments or conditions (as exemplified below), your independent verification and confirmation of product performance, reliability, etc. prior to use, must be necessary:
  - Use of our Products in any types of liquid, including water, oils, chemicals, and organic solvents
  - Use of our Products outdoors or in places where the Products are exposed to direct sunlight or dust
  - Use of our Products in places where the Products are exposed to sea wind or corrosive gases, including Cl<sub>2</sub>, H<sub>2</sub>S, NH<sub>3</sub>, SO<sub>2</sub>, and NO<sub>2</sub>
  - Use of our Products in places where the Products are exposed to static electricity or electromagnetic waves
  - Use of our Products in proximity to heat-producing components, plastic cords, or other flammable items
  - Sealing or coating our Products with resin or other coating materials
  - Use of our Products without cleaning residue of flux (even if you use no-clean type fluxes, cleaning residue of flux is recommended); or Washing our Products by using water or water-soluble cleaning agents for cleaning residue after soldering
  - Use of the Products in places subject to dew condensation
- The Products are not subject to radiation-proof design.
- Please verify and confirm characteristics of the final or mounted products in using the Products.
- In particular, if a transient load (a large amount of load applied in a short period of time, such as pulse. is applied, confirmation of performance characteristics after on-board mounting is strongly recommended. Avoid applying power exceeding normal rated power; exceeding the power rating under steady-state loading condition may negatively affect product performance and reliability.
- De-rate Power Dissipation (Pd) depending on Ambient temperature (Ta). When used in sealed area, confirm the actual ambient temperature.
- Confirm that operation temperature is within the specified range described in the product specification.
- ROHM shall not be in any way responsible or liable for failure induced under deviant condition from what is defined in this document.

## Precaution for Mounting / Circuit board design

- When a highly active halogenous (chlorine, bromine, etc.) flux is used, the residue of flux may negatively affect product performance and reliability.
- In principle, the reflow soldering method must be used on a surface-mount products, the flow soldering method must be used on a through hole mount products. If the flow soldering method is preferred on a surface-mount products, please consult with the ROHM representative in advance.

For details, please refer to ROHM Mounting specification

**Precautions Regarding Application Examples and External Circuits**

1. If change is made to the constant of an external circuit, please allow a sufficient margin considering variations of the characteristics of the Products and external components, including transient characteristics, as well as static characteristics.
2. You agree that application notes, reference designs, and associated data and information contained in this document are presented only as guidance for Products use. Therefore, in case you use such information, you are solely responsible for it and you must exercise your own independent verification and judgment in the use of such information contained in this document. ROHM shall not be in any way responsible or liable for any damages, expenses or losses incurred by you or third parties arising from the use of such information.

**Precaution for Electrostatic**

This Product is electrostatic sensitive product, which may be damaged due to electrostatic discharge. Please take proper caution in your manufacturing process and storage so that voltage exceeding the Products maximum rating will not be applied to Products. Please take special care under dry condition (e.g. Grounding of human body / equipment / solder iron, isolation from charged objects, setting of ionizer, friction prevention and temperature / humidity control).

**Precaution for Storage / Transportation**

1. Product performance and soldered connections may deteriorate if the Products are stored in the places where:
  - [a] the Products are exposed to sea winds or corrosive gases, including Cl<sub>2</sub>, H<sub>2</sub>S, NH<sub>3</sub>, SO<sub>2</sub>, and NO<sub>2</sub>
  - [b] the temperature or humidity exceeds those recommended by ROHM
  - [c] the Products are exposed to direct sunshine or condensation
  - [d] the Products are exposed to high Electrostatic
2. Even under ROHM recommended storage condition, solderability of products out of recommended storage time period may be degraded. It is strongly recommended to confirm solderability before using Products of which storage time is exceeding the recommended storage time period.
3. Store / transport cartons in the correct direction, which is indicated on a carton with a symbol. Otherwise bent leads may occur due to excessive stress applied when dropping of a carton.
4. Use Products within the specified time after opening a humidity barrier bag. Baking is required before using Products of which storage time is exceeding the recommended storage time period.

**Precaution for Product Label**

QR code printed on ROHM Products label is for ROHM's internal use only.

**Precaution for Disposition**

When disposing Products please dispose them properly using an authorized industry waste company.

**Precaution for Foreign Exchange and Foreign Trade act**

Since concerned goods might be fallen under listed items of export control prescribed by Foreign exchange and Foreign trade act, please consult with ROHM in case of export.

**Precaution Regarding Intellectual Property Rights**

1. All information and data including but not limited to application example contained in this document is for reference only. ROHM does not warrant that foregoing information or data will not infringe any intellectual property rights or any other rights of any third party regarding such information or data.
2. ROHM shall not have any obligations where the claims, actions or demands arising from the combination of the Products with other articles such as components, circuits, systems or external equipment (including software).
3. No license, expressly or implied, is granted hereby under any intellectual property rights or other rights of ROHM or any third parties with respect to the Products or the information contained in this document. Provided, however, that ROHM will not assert its intellectual property rights or other rights against you or your customers to the extent necessary to manufacture or sell products containing the Products, subject to the terms and conditions herein.

**Other Precaution**

1. This document may not be reprinted or reproduced, in whole or in part, without prior written consent of ROHM.
2. The Products may not be disassembled, converted, modified, reproduced or otherwise changed without prior written consent of ROHM.
3. In no event shall you use in any way whatsoever the Products and the related technical information contained in the Products or this document for any military purposes, including but not limited to, the development of mass-destruction weapons.
4. The proper names of companies or products described in this document are trademarks or registered trademarks of ROHM, its affiliated companies or third parties.

**General Precaution**

1. Before you use our Products, you are requested to carefully read this document and fully understand its contents. ROHM shall not be in any way responsible or liable for failure, malfunction or accident arising from the use of any ROHM's Products against warning, caution or note contained in this document.
2. All information contained in this document is current as of the issuing date and subject to change without any prior notice. Before purchasing or using ROHM's Products, please confirm the latest information with a ROHM sales representative.
3. The information contained in this document is provided on an "as is" basis and ROHM does not warrant that all information contained in this document is accurate and/or error-free. ROHM shall not be in any way responsible or liable for any damages, expenses or losses incurred by you or third parties resulting from inaccuracy or errors of or concerning such information.



LM2901DT - Web Page

[Distribution Inventory](#)

|                             |              |
|-----------------------------|--------------|
| Part Number                 | LM2901DT     |
| Package                     | SO package14 |
| Unit Quantity               | 2500         |
| Minimum Package Quantity    | 2500         |
| Packing Type                | Taping       |
| Constitution Materials List | inquiry      |
| RoHS                        | Yes          |